

Fiberglass Grating Products
Edition 3



CONTENTS

- About AMD 1
- Industrial Usage & Popular Applications 2
- Features & Advantages 3-4
- Raw Material Choices 5
- Color Choices & Fasteners 6
- Corrosion Resistance Charts 7-8
- AMD Molded FRP Grating 9-20
- AMD Pultruded FRP Grating 21-26
- Ladders, Platforms, Handrails & Fabrications 27-28
- Pultruded Profiles 29-32
- AMD Specialty Items 33

About AMD

AMD, inc. was founded with the clear guiding principle of providing our customers with the highest caliber FRP products at the most competitive price. We have both the knowledge and expertise to help you select the perfect FRP product for each individual project.

We know that the overall cost of material is at times the key deciding factor when selecting FRP Grating. AMD Fiberglass Grating offers a significant cost savings over other traditional materials as it provides years of UV protection, weather, and corrosion resistance. Since our inception, AMD has developed partnerships with the best manufacturers and suppliers throughout the world allowing us to stand behind the exceptional quality of every single product we ship to you.

AMD, inc. prides itself on providing an up front, straight forward approach when working with you and your project's needs. Our dedicated staff will diligently work with you and oversee all orders from start to finish while providing industry leading customer service. Our philosophy is that our service *WILL* set us apart.

We thank you for taking the time to look over our detailed product catalogue and look forward to servicing your future needs.



Features & Advantages of Fiberglass Grating

Non-Corrosive and Chemical Resistance

The leading problem with standard metal grating and wood flooring in today's salt water docks, chemical, power, waste water, and food and beverage plants is Corrosion. AMD grating is specifically designed to provide a safe, long-lasting, economical, and worry-free solution when used in a chemically corrosive environment. Depending on the different environmental requirements, AMD, inc. offers four different resin systems. Please see our Resin System Chart on page 5 for more information.

High Strength-to-Weight Ratio

AMD Grating is manufactured by the joining of continuous fiberglass strands and the highest quality resin to form an integrally strong constructed composite. The end product results in the grating having superior strength but weighing in at half of steel grating. This allows for easy installation with no heavy equipment and less manpower and also makes for easy removal for access below floor level. Properly installed, AMD gratings meet/exceed specified load requirements for steel and are more impact resistant than metal.

Fire Retardant

We ensure that all of our gratings meet and exceed the ASTM- E-84 Fire Spread Test with a spread rating of 25 or below. All of our ASTM Test reports can be found on our new website www.amdgrating.com. If your grating requires an extremely high fire retardant capability in a highly flammable area, we have the ability to use stronger resins and additives by request.

Ergonomic

Fatigue will occur after standing on solid concrete or heavy nonadjustable steel platforms hour after hour. AMD grating has a natural resiliency that makes it comfortable to stand on for long periods of time. This natural resiliency will give your employees a Safe and Non-Slip work area that will reduce strains in the back, legs, and feet resulting in a happier more productive employee.

Low Maintenance

AMD FRP Grating will provide years of maintenance-free ownership. There will be no worrying about rust building up, welding newly formed holes in the material, corrosion from chemicals, or theft from a local metal scrapper. Our gratings will keep their original color and structural properties year after year due to our Molded-In color process and use of our specially designed UV inhibitors.

AMD Gratings are easy to clean and with the open mesh surface allow debris to fall through and prevents hazardous build up on walking surfaces. The combination of these key features will naturally preserve your investment for years to come.

Industrial Useage & Popular Applications of Fiberglass Grating

- Chemical & Petroleum
- Printing & Dyeing
- Marine
- Power
- Pharmaceutical
- Metallurgical
- Transportation
- Shipyard
- Oil Processing/Refining
- Electronics
- Offshore
- Food & Beverage
- Pulp & Paper
- Water & Water Treatment



Longevity

AMD, inc. guarantees that when used under normal non abusive conditions our gratings will have a life span of 20 years or more.

Slip-Resistant

A slippery platform or walkway can be a major enemy in any work place. AMD Anti Slip Resistant Gratings have proven to greatly reduce these work related accidents. With this in mind, we offer a number of different surface types for our grating.

When our grating is first extruded from the mould, it has a concave or meniscus surface on the top of the panel (available by request). To add an extra level of slip protection, we bond our specially designed Anti-Slip Grit to the top of the panel giving it course but safe walking field.

We have a number of different Grits available by request but use a strong, Medium course grit on all of our stocked items. When used in an area where there will be barefoot traffic we recommend the use of our AMD Pool Grit which will provide the proper slip resistance but be soft for bare skin.

Electrical Safety

The NON-CONDUCTIVE and NON- MAGNETIC property of AMD grating makes it the only choice when choosing a flooring option in an electrical hazardous or electrically sensitive area. You will also find all AMD FRP gratings and structural shapes to be NON SPARKING, which makes it the best choice where combustible gases are present and the accidental dropping of a tool on steel grating could produce sparks.

Cost Effective

When factoring the initial (rising) cost of steel/metal, the cost of installation (20%-40% less than steel), the year to year constant maintenance of metal materials, and the comprehensive economical efficiency, the clear choice is AMD Fiberglass Grating.

We encourage you to contact one of our dedicated staff to help you choose the best and most cost effective grating for your project.

Resin Systems

Resin Base	Resin Type	Description	Application
Vinyl ester	Type V	Superior corrosion resistance and fire retardant, flame spread rating ASTM E84 Class 1, 25 or less, operation temperature -50 - 110 °C.	This grating is recommended for use in environments with serious corrosion.
High flame resistant vinyl ester	Type HV	Superior corrosion resistance and enhanced fire retardant, flame spread rating ASTM E84 Class 1, 10 or less, operation temperature -50 - 110 °C. Such grating has passed assessment from ABS (American Bureau of Shipping).	This grating is recommended for use in environments with serious corrosion requiring better flame resistance.
Isophthalic polyester	Type I	Industrial grade corrosion resistance and fire retardant, flame spread rating ASTM E84 Class 1, 25 or less, operation temperature -50 - 105°C.	This grating is recommended for use in environments of middle concentration inorganic acid, inorganic alkali, etc.
Food grade polyester resin	Type F	Food grade corrosion resistance and fire retardant, operation temperature - 50 - 105 °C.	This grating is recommended for use in food plants or drinking water plants.
Orthophthalic polyester resin	Type O	Moderate corrosion resistance and fire retardant, flame spread rating ASTM E84 Class 1, 25 or less, operation temperature -50 - 100 °C.	This grating is recommended for use in water/wastewater or air-aging applications, light industrial applications, and in the wavezone areas of offshore platforms where the environment is moderate. Although Type O is the least chemical resistant resin, it still offers superior performance to traditional flooring products such as steel, aluminum and wood, and is the most economical resin available.
Phenolic resin	Type P	Low smoke and superior fire resistance, flame spread rating ASTM E84 Class 1, 5 or less, smoke developed index o, operation temperature	This grating is recommended for use in areas where fire resistance, low smoke, and low toxic fumes are critical.

Fiberglass

Ingredient	Specification	Property	Application
E-glass	2400TEX or 4800TEX	Excellent soaking ability ensures solid combination with resin, thus perfect physical property and anti-corrosion property.	For environments requiring high strength and corrosion resistance.
C-glass	2400TEX	Excellent soaking ability ensures solid combination with resin and good anti-acid property.	For environments without alkali corrosion.



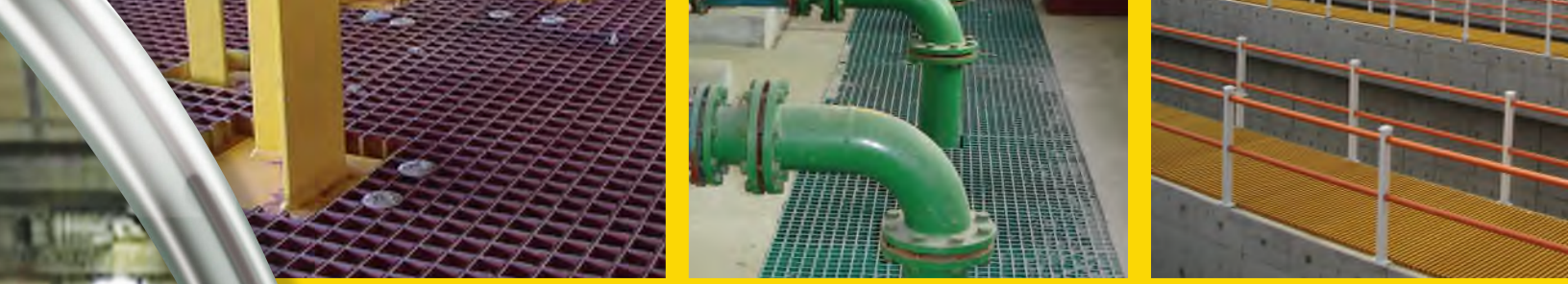

FRP Grating Corrosion Resistance

Chemical	Type V		Type I		Type O	
	Con (%)	Temp (°F/°C)	Con (%)	Temp (°F/°C)	Con (%)	Temp (°F/°C)
Acetic Acid	50	180/82	50	125/52	5	77/25
Aluminum Hydroxide	100	180/82	100	160/71	All	-
Ammonium Chloride	All	210/99	All	170/77	All	-
Ammonium Bicarbonate	50	160/70	15	125/52	All	-
Methacrylic Acid	99	95/35	-	-	-	-
Ammonium Hydroxide	28	100/38	28	N/R	All	N/R
Ammonium Sulfate	All	210/99	All	170/77	All	-
Benzene	100	92/40	All	N/R	All	N/R
Benzoic Acid	Sat	210/99	Sat	150/66	All	77/25
Borax	Sat	210/99	Sat	170/77	Sat	113/45
Calcium Carbide	All	180/82	All	170/77	All	-
Calcium Nitrate	All	210/99	All	180/82	All	-
Carbon Tetrachloride	100	92/40	100	N/R	100	N/R
Chlorine, Dry Gas	-	210/99	-	140/60	-	N/R
Chlorine Water	Sat	200/93	Sat	80/27	Sat	N/R
Chromic Acid	10	150/65	5	70/21	5	N/R
Citric Acid	All	210/99	All	170/77	All	77/25
Calcium Chloride	All	210/99	All	170/77	All	104/40
Copper Cyanide	All	210/99	All	170/77	All	77/25
Copper Nitrate	All	210/99	All	170/77	All	-
Ethanol	50	90/32	50	75/24	10	77/25
Ethylene Glycol	100	200/93	100	90/32	100	75/24
Hydrofluoric Acid	10	149/65	-	-	-	-
Ferric Chloride	All	210/99	All	170/77	All	104/40
Ferrous Chloride	All	210/99	All	170/77	All	86/30
Formaldehyde	All	100/38	50	75/24	25	86/30
Gasoline	100	180/82	100	95/35	100	75/24
Glucose	100	210/99	100	170/77	All	-
Glycerine	100	210/99	100	150/66	100	-
Hydrobromic Acid	50	150/65	50	120/49	18	-
Hydrochloric Acid	37	150/65	37	75/24	10	86/30
Hydrogen Peroxide	30	150/65	5	100/38	5	N/R

Available Colors

AMD grating is available in the following colors:



Custom colors available upon request.

Fasteners

AMD offers the following clips made of 316 stainless steel for securing FRP grating in a wide variety of applications: C-clips and M-clips.

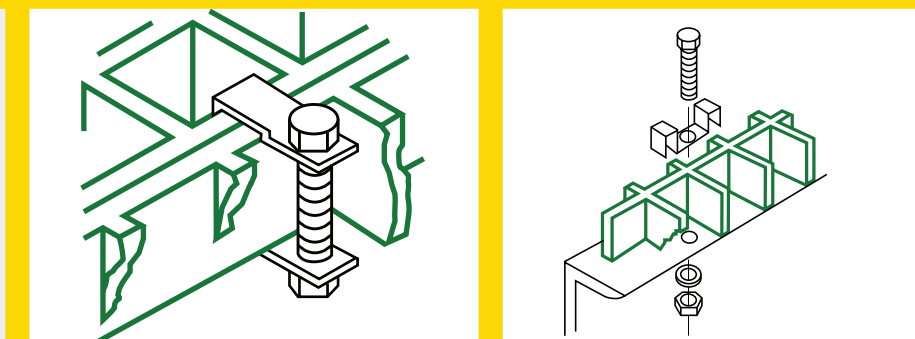

Grating clips are used to secure each piece of grating. AMD recommends using at least eight (8) clips on a 4' x 12' panel. Smaller panels must be fastened with no fewer than four (4) clips.

In any installation, grating fasteners must have low profiles to eliminate trip hazards.





FRP Grating Corrosion Resistance Con't

Chemical	Type V		Type I		Type O	
	Con (%)	Temp (°F/°C)	Con (%)	Temp (°F/°C)	Con (%)	Temp (°F/°C)
Lactic Acid	All	210/99	All	170/77	All	77/25
Lithium Chloride	Sat	210/99	Sat	150/66	All	-
Magnesium Chloride	All	210/99	All	170/77	All	104/40
Magnesium Nitrate	All	210/99	All	140/60	All	86/30
Magnesium Sulfate	All	210/99	All	170/77	All	104/40
Mercuric Chloride	100	210/99	100	150/66	100	104/40
Mercurous Chloride	All	210/99	All	140/60	All	104/40
Nickle Chloride	All	210/99	All	170/77	All	104/40
Nickel Sulfate	All	210/99	All	170/77	All	104/40
Nitric Acid	20	130/54	20	70/21	20	N/R
Oxalic Acid	All	210/99	All	75/24	All	N/R
Perchloric Acid	30	100/38	10	N/R	10	N/R
Phosphoric Acid	100	210/99	100	120/49	80	N/R
Potassium Chloride	All	210/99	All	170/77	All	104/40
Potassium Dichromate	All	210/99	All	170/77	All	77/25
Potassium Nitrate	All	210/99	All	170/77	All	104/40
Potassium Sulfate	All	210/99	All	170/77	All	104/40
Propylene Glycol	All	210/99	All	170/77	All	104/40
Sodium Acetate	All	210/99	All	160/71	All	104/40
Sodium Bisulfate	All	210/99	All	170/77	All	-
Sodium Bromide	All	210/99	All	170/77	5	-
Sodium Cyanide	All	210/99	All	170/77	5	N/R
Sodium Hydroxide	25	180/82	N/R	N/R	N/R	N/R
Sodium Nitrate	All	210/99	All	170/77	All	104/40
Sodium Sulfate	All	210/99	All	170/77	All	104/40
Stannic Chloride	All	210/99	All	160/71	All	104/40
Sulfuric Acid	50	183/80	25	75/24	10	-
Tartaric Acid	All	210/99	All	170/77	All	-
Vinegar	100	210/99	100	170/77	All	-
Methanol	10	183/84	N/R	N/R	N/R	N/R
Sea Water	All	210/99	All	158/70	All	113/45
Water, Distilled	100	180/82	100	170/77	All	86/30
Zinc Nitrate	All	210/99	All	170/77	All	104/40
Zinc Sulfate	All	210/99	All	170/77	All	104/4



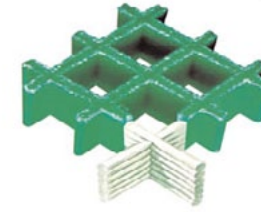

AMD Molded FRP Grating Specifications

Item	Height (in)	Mesh Size (in)	Standard Panel Size (ft)	Open Area	Weight (lbs/ft ²)
1	0.5	2x2	4x12	76%	1.2
2	0.6	1.5x1.5	4x12	69	1.4
3	0.78	1.5x1.5	4x12	69	1.9
4	0.78	1.57x1.57	3x13	70	1.8
5	1.0	1.5x1.5	4x12	69	2.5
6	1.0	1.57x1.57	3x13	70	2.5
7	1.25	1.5x1.5	3x13	68	3
8	1.25	1.57x1.57	3x13	69	2.9
9	1.5	1.5x1.5	5x13	66	3.8
10	1.5	1.57x1.57	3x13	67	3.4
11	1.5	1.5x1.5	4x13	67	4
12	1.5	2x2	4x12	69	3.4
13	2.0	2x2	5x13	69	4.5
14	2.0	2x2	4x12	66	4.8
15	2.0	1.95x1.95	4x6	68	4.5
16	2.0	1.5x1.5	4x12	58	5.8
17	2.0	1.5x1.5	4x12	48	8.2
18	2.36	1.5x1.5	4x12	58	7.4
19	2.36	1.5x1.5	4x12	46	10.1
20	2.5	1.5x1.5	4x12	58	7.6
21	2.5	1.5x1.5	4x12	46	10.6
22	1.1	1.5x1.5	4x12	68	3.0
23	1.5	1.5x1.5	4x12	66	3.5
24	2.0	2x2	4x12	66	4.4
25	1.0	1x4	4x12	67	2.8

AMD Molded FRP Grating Specifications

Item	Height (in)	Mesh Size (in)	Standard Panel Size (ft)	Open Area	Weight (lbs/ft ²)
26	1	1x4	4x12	67%	2.5
27	1	4x1	4x12	67%	2.5
28	1.18	6x1	4x12	68%	3.2
29	1.18	4x1.5	3x13	76%	2.3
30	1.5	6x1	4x12	68%	4.1
31	1.5	4x1.5	3x13	76%	2.8
32	1.57	8.66x2.36	4.94x7.24	85%	1.8
33	1.5	6x1.5	4x12	72%	3.3
34	2.0	6x1.5	4x12	72%	4.2
35	.60	1x1/2x2	4x12	57%	1.4
36	.60	.78x.78/1.5x.15	4x13.27	47%	2
37	.78	.5x.5/1.5x.15	3.18x11.26	27%	3.4
38	1.0	.74x.74/1.5x1.5	4x13.13	44%	3
39	1.25	.78x.78/1.57x1.57	4x13.27	42%	3.6
40	1.25	.5x.5/1.5x1.5	4x13.25	30%	4.5
41	1.25	1x1/2x2	3.77x13.15	56%	2.7
42	1.5	.75x.75/1.5x1.5	4x13.27	40%	4.6
43	1.5	.78x.78/1.57x1.57	4x13.27	42%	4.5
44	1.5	1x1/2x2	4.11x13.15	53%	3.7
45	1.5	.78x.78/1.57x1.57	4x13.27	42%	4.8
46	2.0	1x1/2x2	4x12	47%	5.5

Specification drawing

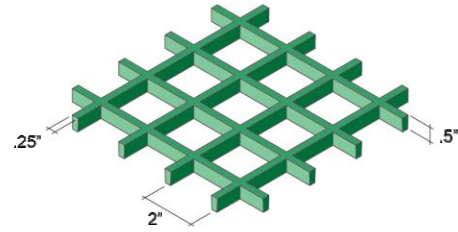

- 1 Height: 0.50" Mesh Size: 0.5" x 0.5"
 • Standard Panel Size: 4 ft x 12 ft
 • Open Area: 76% • Weight: 1.2 lb/f²

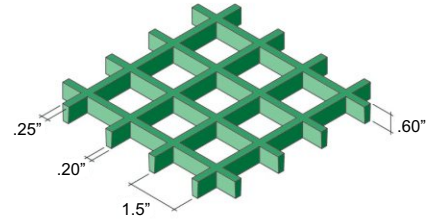

- 2 Height: 0.60" Mesh Size: 1.5" x 1.5"
 • Standard Panel Size: 4 ft x 12 ft
 • Open Area: 69% • Weight: 1.4 lb/f²

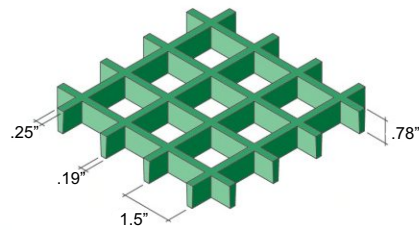

- 3 Height: 0.78" Mesh Size: 1.5" x 1.5"
 • Standard Panel Size: 4 ft x 12 ft
 • Open Area: 69% • Weight: 1.9 lb/f²

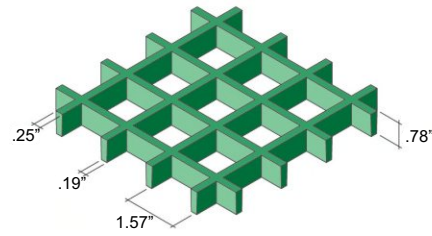

- 4 Height: 0.78" Mesh Size: 1.57" x 1.57"
 • Standard Panel Size: 3 ft x 13 ft
 • Open Area: 70% • Weight: 1.8 lb/f²

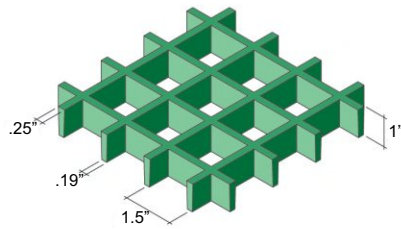

- 5 Height: 1" Mesh Size: 1.5" x 1.5"
 • Standard Panel Size: 4 ft x 12 ft
 • Open Area: 69% • Weight: 2.5 lb/f²

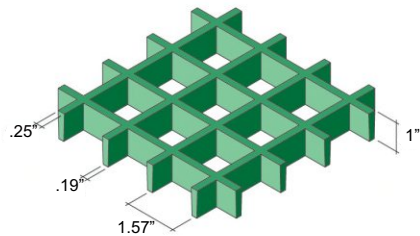

- 6 Height: 1" Mesh Size: 1.57" x 1.57"
 • Standard Panel Size: 3 ft x 13 ft
 • Open Area: 70% • Weight: 2.5 lb/f²

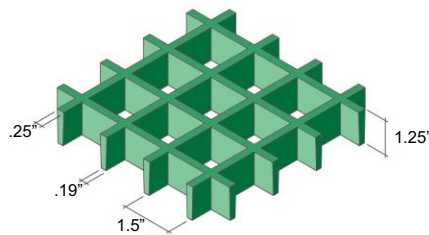

- 7 Height: 1.25" Mesh Size: 1.5" x 1.5"
 • Standard Panel Size: 5 ft x 13 ft
 • Open Area: 68% • Weight: 3 lb/f²

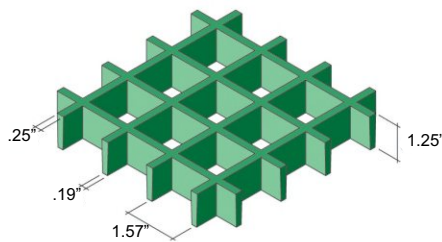

- 8 Height: 1.25" Mesh Size: 1.57" x 1.57"
 • Standard Panel Size: 3 ft x 13 ft
 • Open Area: 69% • Weight: 2.9 lb/f²

Specification drawing

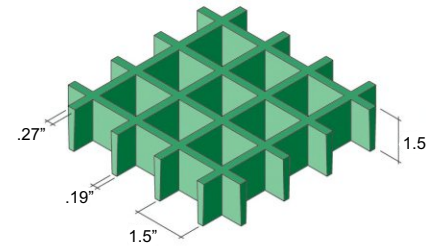

- 9 Height: 1.5" Mesh Size: 1.5" x 1.5"
 • Standard Panel Size: 5 ft x 13 ft
 • Open Area: 66% • Weight: 3.8 lb/f²

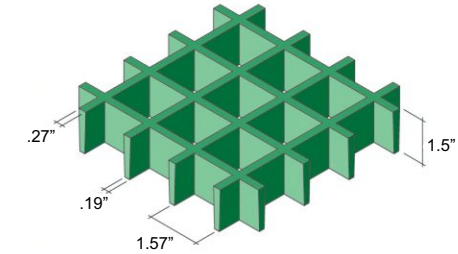

- 10 Height: 1.5" Mesh Size: 1.57" x 1.57"
 • Standard Panel Size: 3 ft x 13 ft
 • Open Area: 67% • Weight: 3.4 lb/f²

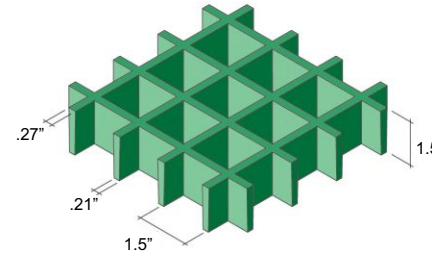

- 11 Height: 1.5" Mesh Size: 1.5" x 1.5"
 • Standard Panel Size: 4 ft x 13 ft
 • Open Area: 67% • Weight: 4 lb/f²

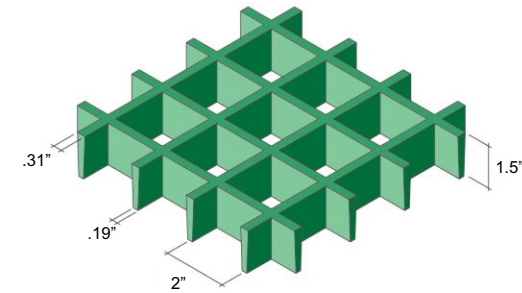

- 12 Height: 1.5" Mesh Size: 2" x 2"
 • Standard Panel Size: 4 ft x 12 ft
 • Open Area: 69% • Weight: 3.4 lb/f²

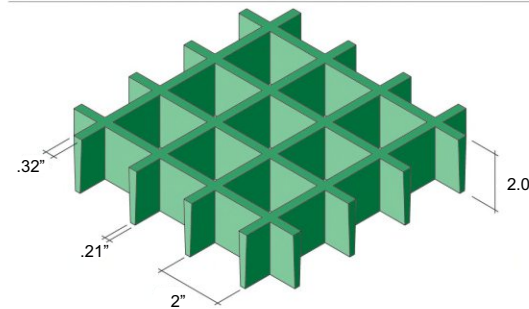

- 13 Height: 2.0" Mesh Size: 2" x 2"
 • Standard Panel Size: 5 ft x 13 ft
 • Open Area: 69% • Weight: 4.5 lb/f²

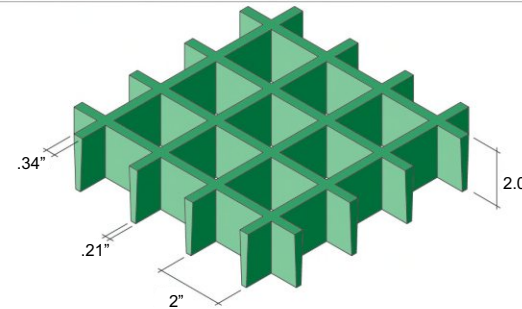

- 14 Height: 2.0" Mesh Size: 2" x 2"
 • Standard Panel Size: 4 ft x 12 ft
 • Open Area: 68% • Weight: 4.8 lb/f²

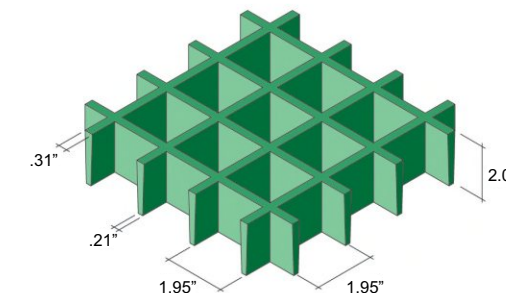

- 15 Height: 2.0" Mesh Size: 1.95" x 1.95"
 • Standard Panel Size: 4 ft x 6 ft
 • Open Area: 68% • Weight: 4.5 lb/f²

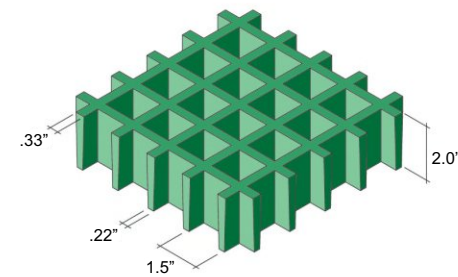

- 16 Height: 2.0" Mesh Size: 1.5" x 1.5"
 • Standard Panel Size: 4 ft x 12 ft
 • Open Area: 58% • Weight: 5.8 lb/f²

Specification drawing

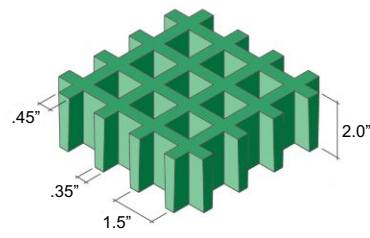

- 17 Height: 2.0" Mesh Size: 1.5" x 1.5"
 • Standard Panel Size: 4 ft x 12 ft
 • Open Area: 48% • Weight: 8.2 lb/f²

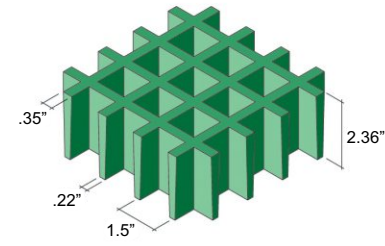

- 18 Height: 2.36" Mesh Size: 1.5" x 1.5"
 • Standard Panel Size: 4 ft x 12 ft
 • Open Area: 58% • Weight: 7.4 lb/f²

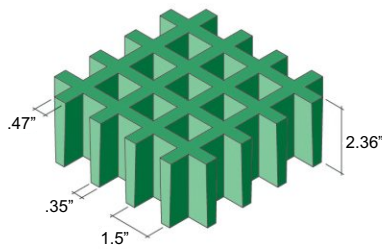

- 19 Height: 2.36" Mesh Size: 1.5" x 1.5"
 • Standard Panel Size: 4 ft x 12 ft
 • Open Area: 46% • Weight: 10.1 lb/f²

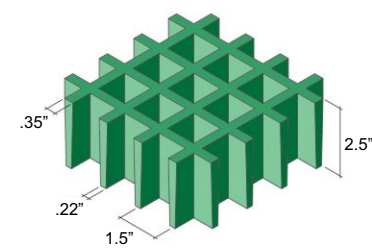

- 20 Height: 2.5" Mesh Size: 1.5" x 1.5"
 • Standard Panel Size: 4 ft x 12 ft
 • Open Area: 58% • Weight: 7.6 lb/f²

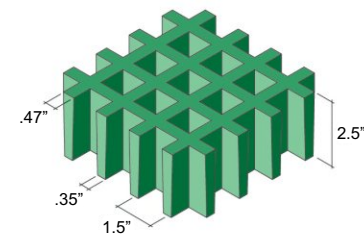

- 21 Height: 2.5" Mesh Size: 1.5" x 1.5"
 • Standard Panel Size: 4 ft x 12 ft
 • Open Area: 46% • Weight: 10.6 lb/f²

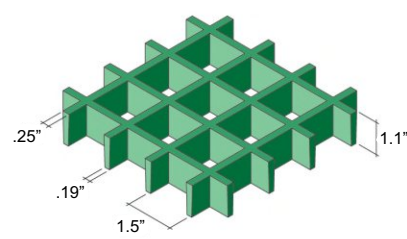

- 22 Height: 1.1" Mesh Size: 1.5" x 1.5"
 • Standard Panel Size: 4 ft x 12 ft
 • Open Area: 68% • Weight: 30 lb/f²

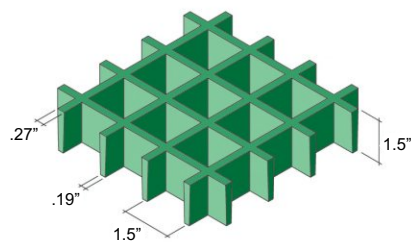

- 23 Height: 1.5" Mesh Size: 1.5" x 1.5"
 • Standard Panel Size: 4 ft x 12 ft
 • Open Area: 66% • Weight: 3.5 lb/f²

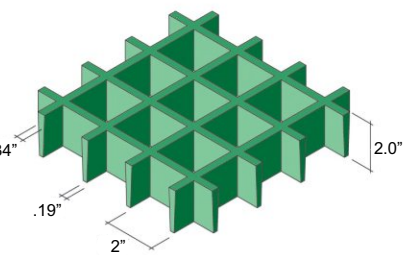

- 24 Height: 2.0" Mesh Size: 2" x 2"
 • Standard Panel Size: 4 ft x 12 ft
 • Open Area: 68% • Weight: 4.4 lb/f²

Specification drawing

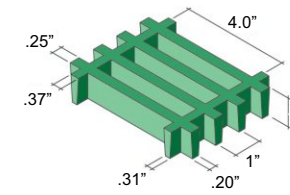

- 25 Height: 1" Mesh Size: 1" x 4.0"
 • Standard Panel Size: 3.31 ft x 9.86 ft (bearing bars to run width direction)
 • Open Area: 67% • Weight: 2.8 lb/f²

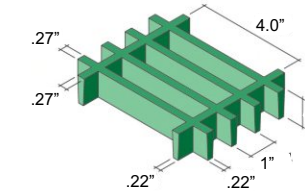

- 26 Height: 1" Mesh Size: 1" x 4.0"
 • Standard Panel Size: 4 ft x 12 ft (bearing bars to run width direction)
 • Open Area: 67% • Weight: 2.5 lb/f²

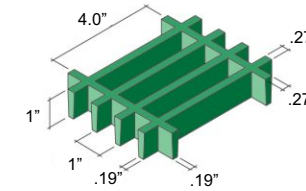

- 27 Height: 1" Mesh Size: 4" x 1"
 • Standard Panel Size: 4 ft x 12 ft (bearing bars to run width direction)
 • Open Area: 67% • Weight: 2.5 lb/f²

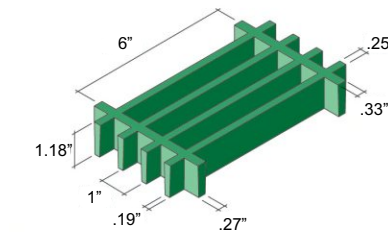

- 28 Height: 1.18" Mesh Size: 6" x 1"
 • Standard Panel Size: 4 ft x 12 ft (bearing bars to run length direction)
 • Open Area: 68% • Weight: 3.2 lb/f²

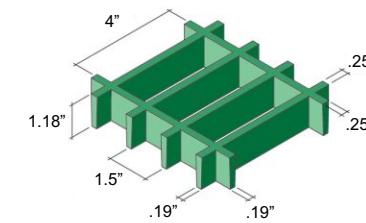

- 29 Height: 1.18" Mesh Size: 4" x 1.5"
 • Standard Panel Size: 4 ft x 12 ft (bearing bars to run length direction)
 • Open Area: 76% • Weight: 2.3 lb/f²

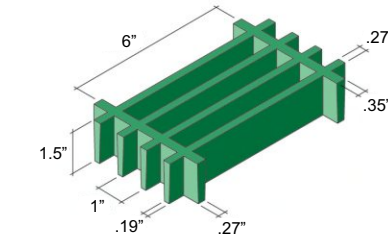

- 30 Height: 1.5" Mesh Size: 6" x 1"
 • Standard Panel Size: 4 ft x 12 ft (bearing bars to run length direction)
 • Open Area: 68% • Weight: 4.1 lb/f²

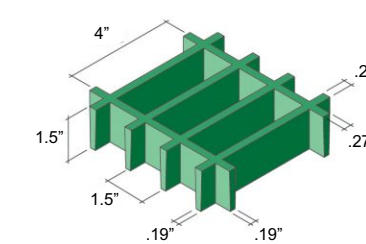

- 31 Height: 1.5" Mesh Size: 4" x 1.5"
 • Standard Panel Size: 4 ft x 12 ft (bearing bars to run length direction)
 • Open Area: 76% • Weight: 2.8 lb/f²

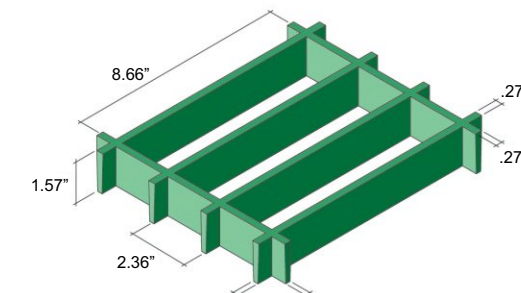

- 32 Height: 1.57" Mesh Size: 8.66" x 2.36"
 • Standard Panel Size: 4.94 ft x 7.24 ft (bearing bars to run length direction)
 • Open Area: 85% • Weight: 1.8 lb/f²

Specification drawing

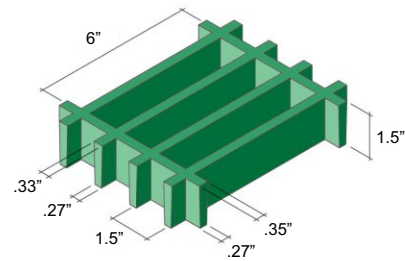

- 33 Height: 1.5" Mesh Size: 6" x 1.5"
 • Standard Panel Size: 4 ft x 12 ft (bearing bars to run length direction)
 • Open Area: 72% • Weight: 3.3 lb/f²

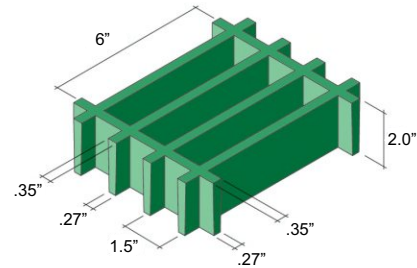

- 34 Height: 2.0" Mesh Size: 6" x 1.5"
 • Standard Panel Size: 4 ft x 12 ft (bearing bars to run length direction)
 • Open Area: 72% • Weight: 4.2 lb/f²

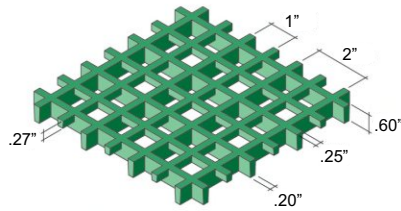

- 35 Height: .6" Mesh Size: 1" x 1" / 2" x 2"
 • Standard Panel Size: 4 ft x 12 ft
 • Open Area: 57% • Weight: 1.4 lb/f²

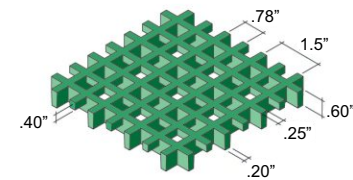

- 36 Height: .6" Mesh Size: .78" x .78" / 1.5" x 1.5"
 • Standard Panel Size: 4 ft x 13.27 ft
 • Open Area: 47% • Weight: 2 lb/f²

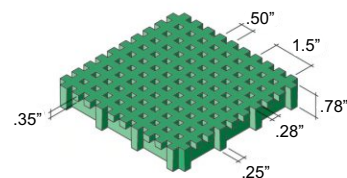

- 37 Height: .78" Mesh Size: .50" x .50" / 1.5" x 1.5"
 • Standard Panel Size: 3.18 ft x 11.26 ft
 • Open Area: 27% • Weight: 3.4 lb/f²

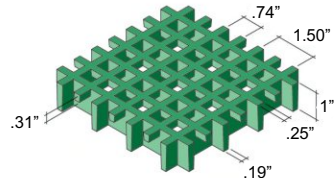

- 38 Height: 1.0" Mesh Size: .74" x .74" / .50" / 1.5" x 1.5"
 • Standard Panel Size: 4 ft x 13.13 ft
 • Open Area: 44% • Weight: 3 lb/f²

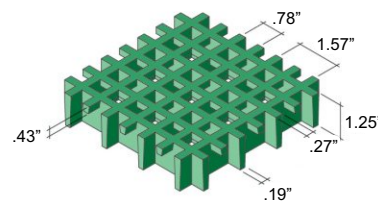

- 39 Height: 1.25" Mesh Size: .78" x .78" / 1.57" x 1.57"
 • Standard Panel Size: 4 ft x 13.27 ft
 • Open Area: 42% • Weight: 3.6 lb/f²

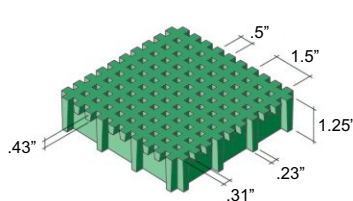

- 40 Height: 1.25" Mesh Size: .50" x .50" / 1.5" x 1.5"
 • Standard Panel Size: 4 ft x 13.25 ft
 • Open Area: 30% • Weight: 4.5 lb/f²

Specification drawing

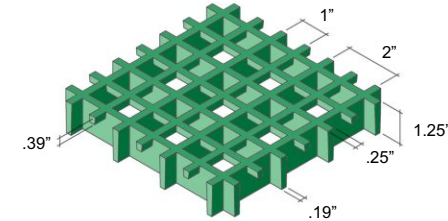

- 41 Height: 1.25" Mesh Size: 1" x 1" / 2" x 2"
 • Standard Panel Size: 3.77 ft x 13.15 ft
 • Open Area: 56% • Weight: 2.7 lb/f²

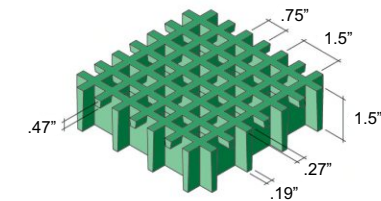

- 42 Height: 1.5" Mesh Size: .75" x .75" / 1.5" x 1.5"
 • Standard Panel Size: 4 ft x 13.27 ft
 • Open Area: 40% • Weight: 4.6 lb/f²

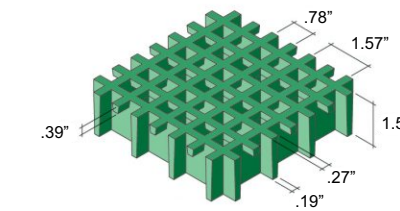

- 43 Height: 1.5" Mesh Size: .78" x .78" / 1.57" x 1.57"
 • Standard Panel Size: 4 ft x 13.27 ft
 • Open Area: 42% • Weight: 4.5 lb/f²

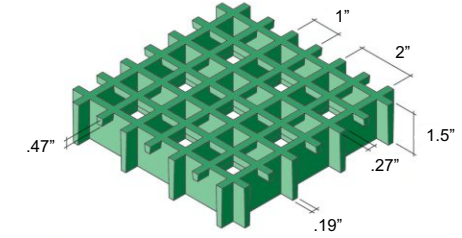

- 44 Height: 1.5" Mesh Size: 1" x 1" / 2" x 2"
 • Standard Panel Size: 4.11 ft x 13.15 ft
 • Open Area: 53% • Weight: 3.7 lb/f²

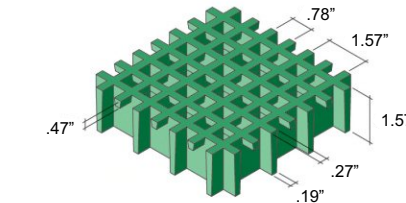

- 45 Height: 1.5" Mesh Size: .78" x .78" / 1.57" x 1.57"
 • Standard Panel Size: 4 ft x 13.27 ft
 • Open Area: 42% • Weight: 4.8 lb/f²

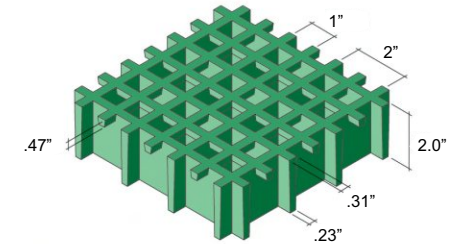

- 46 Height: 2.0" Mesh Size: 1" x 1" / 2" x 2"
 • Standard Panel Size: 4 ft x 12 ft
 • Open Area: 47% • Weight: 5.5 lb/f²



Molded FRP Grating Load & Deflection Data

Concentrated Load

Span	Mesh Size (in)	Ht (in)	Concentrated Load lbs								L/100 lbs
			110	220	440	880	1320	1760	2200	3300	
1'	1.0"4x1.0"/2.0"x2.0"	0.59"	0.030	0.060	0.120	0.240	0.360				440
	1.5"x1.5"	0.59"	0.025	0.050	0.100	0.200	0.300	0.400			528
	0.79"x0.79"/1.57"x1.57"	0.59"	0.024	0.048	0.096	0.192	0.288	0.384			550
	0.50"x0.50"/1.5"x1.5"	0.79"	0.007	0.014	0.027	0.054	0.082	0.109	0.136	0.205	1936
	1.5"x1.5"	1.0"	0.006	0.013	0.026	0.051	0.076	0.102	0.128	0.191	2068
	1.57"x1.57"	1.0"	0.007	0.014	0.027	0.054	0.082	0.089	0.136	0.205	1936
	0.75"x0.75"/1.5"x1.5"	1.0"	0.006	0.011	0.023	0.046	0.070	0.093	0.116	0.174	2275
	1.0"x4.0" bearing bars run width direction	1.0"	0.005	0.009	0.019	0.039	0.058	0.078	0.097	0.145	2728
	1.0"x4.0" bearing bars run width direction	1.0"	0.007	0.014	0.028	0.056	0.083	0.112	0.139	0.209	1892
	1.0"x4.0" bearing bars run length direction	1.0"	0.007	0.013	0.027	0.054	0.080	0.107	0.133	0.200	1980
	1.5"x1.5"	1.2"	0.006	0.011	0.022	0.045	0.067	0.090	0.112	0.169	2350
	1.57"x1.57"	1.2"	0.007	0.013	0.027	0.053	0.080	0.107	0.133	0.200	1980
	0.79"x0.79"/1.57"x1.57"	1.2"	0.005	0.010	0.020	0.040	0.060	0.080	0.100	0.150	2640
	0.5"x0.5"/1.5"x1.5"	1.2"	0.005	0.009	0.018	0.037	0.055	0.073	0.091	0.137	2886
	1.02"x1.02"/2.05"x2.05"	1.2"	0.007	0.015	0.030	0.060	0.090	0.120	0.150	0.225	1760
	1.5"x1.5"	1.5"	0.004	0.008	0.016	0.032	0.048	0.064	0.080	0.120	3300
	1.57"x1.57"	1.5"	0.004	0.008	0.017	0.034	0.051	0.068	0.085	0.128	3102
	1.0"x6.0" bearing bars run length direction	1.5"		0.006	0.013	0.025	0.038	0.050	0.063	0.094	4191
	1.5"x4.0" bearing bars run length direction	1.5"	0.005	0.010	0.020	0.041	0.061	0.081	0.102	0.153	2596
	0.79"x0.79"/1.57"x1.57"	1.5"		0.007	0.014	0.029	0.043	0.057	0.072	0.108	3674
	2.0"x2.0"	2.0"		0.007	0.013	0.026	0.040	0.053	0.067	0.100	3960
	1.0"x1.0"/2.0"x2.0"	2.0"		0.004	0.009	0.017	0.026	0.034	0.043	0.064	6160
1.5'	1.0"4x1.0"/2.0"x2.0"	0.59"	0.100	0.200	0.450						198
	1.5"x1.5"	0.59"	0.095	0.189	0.379						209
	0.79"x0.79"/1.57"x1.57"	0.59"	0.085	0.171	0.343	0.685					231
	0.50"x0.50"/1.5"x1.5"	0.79"	0.021	0.043	0.085	0.171	0.257	0.343	0.428		924
	1.5"x1.5"	1.0"	0.019	0.037	0.075	0.15	0.225	0.3	0.375		1056
	1.57"x1.57"	1.0"	0.020	0.040	0.080	0.160	0.240	0.320	0.400		990
	0.75"x0.75"/1.5"x1.5"	1.0"	0.017	0.033	0.067	0.133	0.201	0.267	0.333	0.5	1188
	1.0"x4.0" bearing bars run width direction?	1.0"	0.013	0.025	0.051	0.101	0.152	0.203	0.254	0.380	1562
	1.0"x4.0" bearing bars run width direction?	1.0"	0.018	0.037	0.073	0.147	0.220	0.294	0.367		1078
	1.0"x4.0" bearing bars run length direction?	1.0"	0.017	0.033	0.065	0.131	0.196	0.262	0.327	0.491	1210
	1.5"x1.5"	1.2"	0.015	0.025	0.05	0.1	0.15	0.2	0.25	0.375	1320
	1.57"x1.57"	1.2"	0.016	0.031	0.063	0.126	0.189	0.252	0.316	0.474	1254
	0.79"x0.79"/1.57"x1.57"	1.2"	0.009	0.022	0.044	0.087	0.13	0.173	0.216	0.324	2200
	0.5"x0.5"/1.5"x1.5"	1.2"	0.008	0.017	0.033	0.066	0.098	0.131	0.163	0.245	2420



Concentrated Load con't

Molded FRP Grating Load & Deflection Data

Span	Mesh Size (in)	Ht (in)	Concentrated Load lbs								L/100 lbs
			110	220	440	880	1320	1760	2200	3300	
1.5'	1.02"x1.02"/2.05"x2.05"	1.2"	0.018	0.035	0.070	0.141	0.212	0.282	0.353	0.529	1122
	1.5"x1.5"	1.5"	0.007	0.013	0.025	0.05	0.075	0.1	0.125	0.187	2640
	1.57"x1.57"	1.5"	0.008	0.016	0.032	0.063	0.095	0.127	0.158	0.237	2499
	1.0"x6.0" bearing bars run length direction	1.5"	0.006	0.011	0.022	0.044	0.065	0.087	0.109	0.163	3639
	1.5"x4.0" bearing bars run length direction	1.5"	0.009	0.018	0.036	0.072	0.107	0.143	0.180	0.269	2209
	0.79"x0.79"/1.57"x1.57"	1.5"	0.007	0.012	0.024	0.047	0.07	0.094	0.117	0.175	2827
	2.0"x2.0"	2.0"	0.006	0.008	0.018	0.033	0.05	0.067	0.083	0.125	3674
	1.0"x1.0"/2.0"x2.0"	2.0"		0.007	0.015	0.029	0.043	0.057	0.072	0.108	5500
	1.5"x6.0" bearing bars run length direction	2.0"		0.007	0.013	0.026	0.039	0.052	0.065	0.098	6072
	1.0"4x1.0"/2.0"x2.0"	0.59"	0.241	0.481							110
	1.5"x1.5"	0.59"	0.219	0.437							121
	0.79"x0.79"/1.57"x1.57"	0.59"	0.200	0.400							132
	0.50"x0.50"/1.5"x1.5"	0.79"	0.044	0.089	0.178	0.356	0.534				594
2'	1.5"x1.5" 1.0"	0.043	0.086	0.172	0.343	0.515					616
	1.5"x1.5"	1.0"	0.086	0.172	0.343	0.515					607
	0.75"x0.75"/1.5"x1.5"	1.0"	0.075	0.15	0.3	0.45	0.6				704
	1.0"x4.0" bearing bars run width direction?	1.0"	0.029	0.057	0.115	0.229	0.343	0.457	0.572		924
	1.0"x4.0" bearing bars run width direction?	1.0"	0.041	0.083	0.166	0.331	0.497	0.663			638
	1.0"x4.0" bearing bars run length direction?	1.0"	0.034	0.069	0.137	0.274	0.412	0.549			770
	1.5"x1.5"	1.2"	0.054	0.108	0.217	0.325	0.433				814
	1.57"x1.57"	1.2"	0.033	0.067	0.133	0.267	0.400	0.534			792
	0.79"x0.79"/1.57"x1.57"	1.2"	0.030	0.05	0.1	0.2	0.3	0.4			880
	0.5"x0.5"/1.5"x1.5"	1.2"	0.026	0.052	0.105	0.210	0.315	0.420	0.524		1008
	1.02"x1.02"/2.05"x2.05"	1.2"	0.034	0.069	0.137	0.274	0.412	0.549			770
	1.5"x1.5"	1.5"	0.014	0.024	0.047	0.094	0.142	0.189	0.236	0.353	1870
	1.57"x1.57"	1.5"	0.015	0.029	0.058	0.116	0.174	0.232	0.290	0.435	1822
	1.0"x6.0" bearing bars run length direction	1.5"	0.010	0.020	0.041	0.082	0.123	0.164	0.205	0.308	2574
	1.5"x4.0" bearing bars run length direction	1.5"	0.017	0.035	0.070	0.139	0.209	0.278	0.348	0.522	1518
	0.79"x0.79"/1.57"x1.57"	1.5"	0.012	0.02	0.041	0.081	0.121	0.161	0.201	0.303	2189
	2.0"x2.0"	2.0"	0.009	0.015	0.03	0.06	0.09	0.12	0.15	0.224	2948
	1.0"x1.0"/2.0"x2.0"	2.0"	0.006	0.012	0.024	0.048	0.072	0.096	0.12	0.18	4400
	1.5"x6.0" bearing bars run length direction	2.0"	0.006	0.011	0.022	0.044	0.066	0.087	0.109	0.164	4840
	1.5"x1.5" (0.35"/0.45")	2.0"	0.006	0.011	0.021	0.043	0.064	0.085	0.107	0.16	4950
	1.5"x1.5" (0.23"/0.35")	2.36"	0.006	0.011	0.021	0.043	0.064	0.085	0.107	0.16	4730
	1.5"x1.5" (0.35"/0.48")	2.36"		0.007	0.015	0.03	0.045	0.06	0.076	0.09	6996



Molded FRP Grating Load & Deflection Data

Concentrated Load con't

Span	Mesh Size (in)	Ht (in)	Concentrated Load lbs							L/100 lbs	
			110	220	440	880	1320	1760	2200		3300
3'	1.5"x1.5"	1.0"	0.120	0.24	0.48						330
	1.57"x1.57"	1.0"	0.128	0.257	0.514						308
	0.75"x0.75"/1.5"x1.5"	1.0"	0.116	0.232	0.464						341
	1.0"x4.0" bearing bars run width direction	1.0"	0.072	0.144	0.288	0.576	0.864				550
	1.0"x4.0" bearing bars run width direction	1.0"	0.103	0.206	0.411	0.822					385
	1.0"x4.0" bearing bars run length direction	1.0"	0.094	0.189	0.379	0.757					418
	1.5"x1.5"	1.25"	0.082	0.136	0.273	0.545					484
1.57"x1.57"	1.25"	0.086	0.171	0.343	0.685					462	
0.79"x0.79"/1.57"x1.57"	1.25"	0.076	0.128	0.256	0.511					517	
0.5"x0.5"/1.5"x1.5"	1.25"	0.067	0.133	0.267	0.533					594	
1.02"x1.02"/2.05"x2.05"	1.25"	0.092	0.185	0.369	0.738					429	
1.5"x1.5"	1.5"	0.037	0.063	0.125	0.25	0.375	0.5			1056	
1.57"x1.57"	1.5"	0.039	0.078	0.156	0.313	0.469	0.626			1012	
1.0"x6.0" bearing bars run length direction	1.5"	0.027	0.054	0.109	0.218	0.327	0.436	0.545		1452	
1.5"x4.0" bearing bars run length direction	1.5"	0.044	0.088	0.176	0.351	0.527	0.702			902	
0.79"x0.79"/1.57"x1.57"	1.5"	0.033	0.055	0.11	0.219	0.327	0.437	0.545		1210	
2.0"x2.0"	2.0"	0.020	0.033	0.067	0.133	0.2	0.267	0.333	0.5	1980	
1.0"x1.0"/2.0"x2.0"	2.0"	0.013	0.026	0.052	0.103	0.154	0.206	0.257	0.386	3080	
1.5"x6.0" bearing bars run length direction	2.0"	0.011	0.023	0.047	0.093	0.140	0.187	0.234	0.351	3388	
1.5"x1.5" (0.35"/0.45")	2.0"	0.011	0.024	0.047	0.094	0.141	0.176	0.235	0.36	3366	
1.5"x1.5" (0.23"/0.35")	2.5"	0.013	0.025	0.050	0.099	0.149	0.198	0.248	0.372	3190	
1.5"x1.5" (0.35"/0.48")	2.5"	0.009	0.017	0.033	0.067	0.101	0.135	0.168	0.252	4708	
1.5"x1.5"	1.5"	0.066	0.12	0.239	0.478	0.718				803	
1.57"x1.57"	1.5"	0.070	0.139	0.278	0.556	0.835				759	
1.0"x6.0" bearing bars run length direction	1.5"	0.044	0.088	0.175	0.350	0.526	0.701			1206	
1.5"x4.0" bearing bars run length direction	1.5"	0.086	0.172	0.343	0.686					616	
0.79"x0.79"/1.57"x1.57"	1.5"	0.061	0.111	0.221	0.442	0.663				869	
4'	2.0"x2.0"	2.0"	0.045	0.083	0.165	0.33	0.494	0.659		1166	
1.0"x1.0"/2.0"x2.0"	2.0"	0.035	0.07	0.139	0.278	0.417	0.556	0.696		1518	
1.5"x6.0" bearing bars run length direction	2.0"	0.031	0.063	0.126	0.253	0.379	0.505	0.632		1672	
1.5"x1.5" (0.35"/0.45")	2.0"	0.026	0.053	0.106	0.212	0.319	0.425	0.531	0.797	1989	
1.5"x1.5" (0.23"/0.35")	2.5"	0.030	0.059	0.119	0.237	0.356	0.474	0.593	0.89	1782	
1.5"x1.5" (0.35"/0.48")	2.5"	0.019	0.038	0.076	0.152	0.228	0.304	0.38	0.569	2783	

Concentrated Line Load

Molded FRP Grating Load & Deflection Data

Span	Mesh Size (in)	Ht (in)	Concentrated Line Load lbs							L/100 lbs	
			110	220	440	880	1320	1760	2200		3300
1'	1.0"x1.0"/2.0"x2.0"	0.59"	0.067	0.133	0.267	0.534					198
	1.5"x1.5"	0.59"	0.057	0.115	0.229	0.457					231
	0.79"x0.79"/1.57"x1.57"	0.59"	0.055	0.109	0.219	0.437					242
	0.50"x0.50"/1.5"x1.5"	0.79"	0.017	0.033	0.067	0.133	0.200	0.267	0.333	0.500	792
	1.5"x1.5"	1.0"	0.013	0.026	0.052	0.104	0.157	0.209	0.261	0.392	1012
	1.57"x1.57"	1.0"	0.014	0.028	0.056	0.112	0.168	0.223	0.280	0.419	946
	0.75"x0.75"/1.5"x1.5"	1.0"	0.012	0.024	0.048	0.095	0.143	0.191	0.237	0.356	1113
	1.0"x4.0" bearing bars run width direction	1.0"	0.006	0.012	0.024	0.048	0.071	0.095	0.119	0.178	2222
1.0"x4.0" bearing bars run width direction	1.0"	0.009	0.017	0.035	0.070	0.104	0.139	0.174	0.261	1518	
	1.5"x1.5"	1.2"	0.011	0.022	0.044	0.087	0.131	0.175	0.219	0.328	1210
	1.57"x1.57"	1.2"	0.011	0.023	0.046	0.093	0.139	0.185	0.231	0.346	1144
	0.79"x0.79"/1.57"x1.57"	1.2"	0.007	0.013	0.027	0.054	0.080	0.107	0.133	0.200	1980
	0.5"x0.5"/1.5"x1.5"	1.2"	0.006	0.012	0.024	0.047	0.070	0.094	0.118	0.177	2244
	1.5"x1.5"	1.5"	0.006	0.011	0.021	0.043	0.064	0.086	0.107	0.161	2464
	1.57"x1.57"	1.5"	0.006	0.011	0.022	0.045	0.068	0.090	0.113	0.169	2345
	1.0"x6.0" bearing bars run length direction	1.5"		0.007	0.013	0.026	0.039	0.052	0.065	0.098	4048
	1.5"x4.0" bearing bars run length direction	1.5"	0.007	0.014	0.027	0.055	0.082	0.109	0.137	0.204	1936
0.79"x0.79"/1.57"x1.57"	1.5"	0.006	0.011	0.022	0.044	0.065	0.087	0.109	0.163	2424	
2.0'	2.0"x2.0"	2.0"		0.007	0.013	0.027	0.040	0.054	0.067	0.100	3960
	1.0"x1.0"/2.0"x2.0"	2.0"		0.006	0.013	0.025	0.038	0.051	0.063	0.095	4167
	1.5"x1.5" (0.35"/0.45")	2.0"		0.005	0.010	0.019	0.029	0.039	0.048	0.073	5434
	1.5"x1.5" (0.23"/0.35")	2.36"		0.005	0.010	0.020	0.031	0.041	0.051	0.077	5170
	1.5"x1.5" (0.35"/0.48")	2.36"		0.007	0.014	0.020	0.027	0.034	0.051	0.077	7766
1.5'	1.0"x1.0"/2.0"x2.0"	0.59"	0.225	0.450							88
	1.5"x1.5"	0.59"	0.187	0.375							106
	0.79"x0.79"/1.57"x1.57"	0.59"	0.180	0.360							110
	0.50"x0.50"/1.5"x1.5"	0.79"	0.056	0.113	0.225	0.450					352
	1.5"x1.5"	1.0"	0.072	0.144	0.288	0.432					550
	1.57"x1.57"	1.0"	0.037	0.075	0.150	0.300	0.450				528
	0.75"x0.75"/1.5"x1.5"	1.0"	0.040	0.063	0.127	0.254	0.381				499
	1.0"x4.0" bearing bars run width direction	1.0"	0.022	0.044	0.088	0.176	0.263	0.351	0.439		902
1.0"x4.0" bearing bars run width direction	1.0"	0.032	0.056	0.112	0.224	0.336				616	
	1.5"x1.5"	1.25"	0.034	0.048	0.097	0.194	0.291				583
	1.57"x1.57"	1.25"	0.036	0.072	0.144	0.288	0.432				550
	0.79"x0.79"/1.57"x1.57"	1.25"	0.024	0.044	0.089	0.177	0.265	0.354			814
	0.5"x0.5"/1.5"x1.5"	1.25"	0.020	0.040	0.080	0.160	0.240	0.320			990
1.5"x1.5"	1.5"	0.013	0.027	0.054	0.109	0.163	0.218	0.273	0.409	1452	

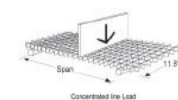

Molded FRP Grating Load & Deflection Data

Concentrated Line Load con't

Span	Mesh Size (in)	Ht (in)	Concentrated Line Load lbs								L/100 lbs
			110	220	440	880	1320	1760	2200	3300	
1.5'	1.57"×1.57"	1.5"	0.014	0.029	0.057	0.114	0.171	0.228	0.285	0.428	1386
	1.0"×6.0" bearing bars run length direction	1.5"	0.010	0.02	0.04	0.079	0.119	0.159	0.198	0.297	1998
	1.5"×4.0" bearing bars run length direction	1.5"	0.015	0.031	0.062	0.124	0.186	0.248	0.31	0.465	1276
	0.79"×0.79"/1.57"×1.57"	1.5"	0.013	0.024	0.049	0.098	0.146	0.196	0.244	0.366	1474
	2.0"×2.0"	2.0"	0.007	0.015	0.03	0.059	0.089	0.118	0.148	0.225	2684
	1.0"×1.0"/2.0"×2.0"	2.0"	0.007	0.014	0.028	0.056	0.084	0.113	0.141	0.211	2816
	1.5"×6.0" bearing bars run length direction	2.0"	0.007	0.013	0.027	0.054	0.081	0.107	0.134	0.202	2948
	1.5"×1.5" (0.35"/0.45")	2.0"	0.005	0.01	0.02	0.04	0.061	0.081	0.101	0.151	3927
	1.5"×1.5" (0.23"/0.35")	2.5"	0.005	0.011	0.021	0.043	0.064	0.085	0.106	0.159	3729
	1.5"×1.5" (0.35"/0.48")	2.5"		0.007	0.014	0.028	0.043	0.056	0.07	0.106	5610
2'	1.0"×1.0"/2.0"×2.0"	0.59"	0.444	0.890							59
	1.5"×1.5"	0.59"	0.364	0.728							73
	0.79"×0.79"/1.57"×1.57"	0.59"	0.343	0.686							77
	0.50"×0.50"/1.5"×1.5"	0.79"	0.109	0.219	0.437	0.873					242
	1.5"×1.5"	1.0"	0.083	0.167	0.333	0.667					317
	1.57"×1.57"	1.0"	0.086	0.172	0.343	0.686					308
	0.75"×0.75"/1.5"×1.5"	1.0"	0.077	0.154	0.308	0.616					343
	1.0"×4.0" bearing bars run width direction	1.0"	0.053	0.106	0.211	0.421	0.632				502
	1.0"×4.0" bearing bars run width direction	1.0"	0.080	0.134	0.267	0.534					330
	1.5"×1.5"	1.25"	0.075	0.125	0.25	0.502					352
	1.57"×1.57"	1.25"	0.080	0.160	0.320	0.641					330
	0.79"×0.79"/1.57"×1.57"	1.25"	0.052	0.104	0.209	0.418	0.627				506
	0.5"×0.5"/1.5"×1.5"	1.25"	0.043	0.086	0.172	0.343	0.515				616
	1.5"×1.5"	1.5"	0.032	0.064	0.128	0.255	0.382	0.51			829
	1.57"×1.57"	1.5"	0.033	0.067	0.133	0.267	0.400	0.534			792
	1.0"×6.0" bearing bars run length direction	1.5"	0.024	0.049	0.098	0.196	0.294	0.392	0.492		1078
	1.5"×4.0" bearing bars run length direction	1.5"	0.037	0.075	0.15	0.3	0.45	0.6			704
	0.79"×0.79"/1.57"×1.57"	1.5"	0.029	0.057	0.114	0.229	0.343	0.457	0.572		924
	2.0"×2.0"	2.0"	0.018	0.035	0.07	0.141	0.212	0.283	0.353	0.53	1496
	1.0"×1.0"/2.0"×2.0"	2.0"	0.017	0.033	0.067	0.134	0.202	0.269	0.336	0.504	1573
	1.5"×6.0" bearing bars run length direction	2.0"	0.016	0.032	0.064	0.128	0.192	0.256	0.32	0.48	1650
	1.5"×1.5" (0.35"/0.45")	2.0"	0.007	0.015	0.03	0.061	0.091	0.121	0.152	0.227	3487
	1.5"×1.5" (0.23"/0.35")	2.5"	0.008	0.02	0.039	0.077	0.115	0.153	0.191	0.291	3322
	1.5"×1.5" (0.35"/0.48")	2.5"	0.005	0.011	0.021	0.042	0.063	0.084	0.106	0.158	5016

Concentrated Line Load con't

Molded FRP Grating Load & Deflection Data

Span	Mesh Size (in)	Ht (in)	Concentrated Line Load lbs								L/100 lbs
			110	220	440	880	1320	1760	2200	3300	
3'	1.5"×1.5"	1.0"	0.290	0.580							136
	1.57"×1.57"	1.0"	0.300	0.600							132
	0.75"×0.75"/1.5"×1.5"	1.0"	0.265	0.529							150
	1.0"×4.0" bearing bars run width direction	1.0"	0.176	0.353	0.706						224
	1.0"×4.0" bearing bars run width direction	1.0"	0.257	0.514							154
		1.5"×1.5"	1.2"	0.180	0.360	0.720					
	1.57"×1.57"	1.2"	0.187	0.375	0.750						211
	0.79"×0.79"/1.57"×1.57"	1.2"	0.156	0.313	0.626						253
	0.5"×0.5"/1.5"×1.5"	1.2"	0.120	0.240	0.480	0.959					330
		1.5"×1.5"	1.5"	0.106	0.212	0.423	0.846				
	1.57"×1.57"	1.5"	0.113	0.225	0.450	0.900					352
	1.0"×6.0" bearing bars run length direction	1.5"	0.082	0.163	0.327	0.654					484
	1.5"×4.0" bearing bars run length direction	1.5"	0.120	0.240	0.480	0.959					330
	0.79"×0.79"/1.57"×1.57"	1.5"	0.095	0.189	0.379	0.757					418
		2.0"×2.0"	2.0"	0.056	0.111	0.221	0.443	0.664	0.886		
	1.0"×1.0"/2.0"×2.0"	2.0"	0.052	0.103	0.206	0.411	0.617	0.823			770
	1.5"×6.0" bearing bars run length direction	2.0"	0.049	0.097	0.194	0.389	0.583	0.778			814
	1.5"×1.5" (0.35"/0.45")	2.0"	0.021	0.043	0.086	0.171	0.257	0.343	0.428	0.643	1848
		1.5"×1.5" (0.23"/0.35")	2.36"	0.022	0.045	0.090	0.180	0.270	0.360	0.450	0.675
	1.5"×1.5" (0.35"/0.48")	2.36"	0.015	0.030	0.060	0.120	0.180	0.240	0.300	0.450	2640
		1.5"×1.5"	1.5"	0.204	0.407	0.814					260
4'	1.57"×1.57"	1.5"	0.222	0.444	0.890						238
	1.0"×6.0" bearing bars run length direction	1.5"	0.150	0.300	0.600						352
	1.5"×4.0" bearing bars run length direction	1.5"	0.214	0.428	0.857						246
	0.79"×0.79"/1.57"×1.57"	1.5"	0.200	0.400	0.800						264
		2.0"×2.0"	2.0"	0.133	0.267	0.533					396
	1.0"×1.0"/2.0"×2.0"	2.0"	0.126	0.253	0.505						418
	1.5"×6.0" bearing bars run length direction	2.0"	0.120	0.240	0.480						440
	1.5"×1.5" (0.35"/0.45")	2.0"	0.073	0.145	0.291	0.582	0.874				726
	1.5"×1.5" (0.23"/0.35")	2.36"	0.076	0.152	0.305	0.609	0.915				693
	1.5"×1.5" (0.35"/0.48")	2.36"	0.051	0.102	0.204	0.408	0.613	0.818			1034

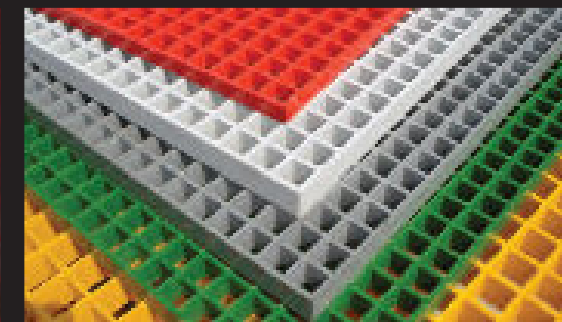
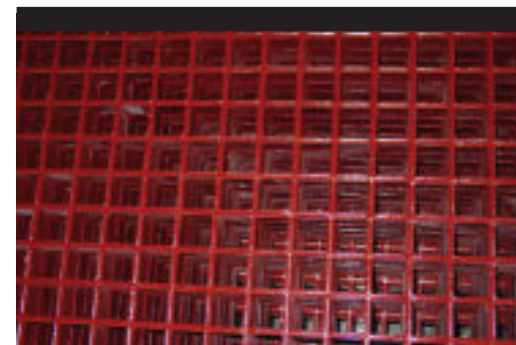

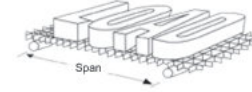
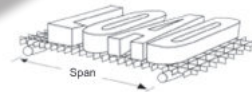

Molded FRP Grating Load & Deflection

Uniform Load

Span	Mesh Size (in)	Ht (in)	Uniform Load (lbs/ft ²)							L/100 (lbs/ft)
			41	82	123	164	246	327	409	
1'	1.0"x1.0"/2.0"x2.0"	0.59"	0.028	0.057	0.085	0.113	0.170	0.226	0.283	174
	1.5"x1.5"	0.59"	0.023	0.047	0.070	0.094	0.141	0.188	0.235	29
	0.79"x0.79"/1.57"x1.57"	0.59"	0.022	0.045	0.067	0.090	0.135	0.180	0.224	219
	0.50"x0.50"/1.5"x1.5"	0.79"	0.008	0.016	0.024	0.032	0.048	0.065	0.081	69
	1.5"x1.5"	1.0"	0.007	0.014	0.021	0.028	0.042	0.056	0.069	78
	1.57"x1.57"	1.0"	0.007	0.015	0.022	0.030	0.045	0.060	0.075	655
	0.75"x0.75"/1.5"x1.5"	1.0"	0.005	0.010	0.015	0.019	0.029	0.039	0.048	113
	1.0"x4.0" bearing bars run width direction	1.0"		0.005	0.008	0.010	0.015	0.020	0.026	195
	1.0"x4.0" bearing bars run width direction	1.0"		0.004	0.009	0.013	0.017	0.026	0.034	1142
	1.5"x1.5"	1.2"	0.004	0.008	0.012	0.017	0.025	0.033	0.041	1197
1.57"x1.57"	1.2"	0.004	0.009	0.013	0.017	0.026	0.034	0.043	1146	
0.79"x0.79"/1.57"x1.57"	1.2"		0.005	0.007	0.010	0.015	0.020	0.025	1957	
0.5"x0.5"/1.5"x1.5"	1.2"		0.005	0.007	0.009	0.014	0.019	0.024	29	
1.5"x1.5"	1.5"			0.005	0.007	0.010	0.013	0.017	2921	
1.57"x1.57"	1.5"			0.005	0.007	0.010	0.014	0.017	2832	
1.0"x6.0" bearing bars run length direction	1.5"				0.004	0.007	0.009	0.011	4462	
1.5"x4.0" bearing bars run length direction	1.5"			0.006	0.007	0.011	0.014	0.018	2772	
0.79"x0.79"/1.57"x1.57"	1.5"			0.005	0.007	0.010	0.013	0.017	2973	
2.0"x2.0"	2.0"			0.004	0.006	0.008	0.011	0.014	358	
1.5'	1.0"x1.0"/2.0"x2.0"	0.59"	0.089	0.177	0.266	0.354				83
	1.5"x1.5"	0.59"	0.073	0.147	0.220	0.294	0.441			1
	0.79"x0.79"/1.57"x1.57"	0.59"	0.070	0.139	0.209	0.279	0.419			16
	0.50"x0.50"/1.5"x1.5"	0.79"	0.031	0.063	0.094	0.125	0.188	0.250	0.313	235
	1.5"x1.5"	1.0"	0.022	0.043	0.065	0.086	0.129	0.171	0.215	287
	1.57"x1.57"	1.0"	0.027	0.054	0.082	0.109	0.163	0.218	0.272	27
	0.75"x0.75"/1.5"x1.5"	1.0"	0.016	0.031	0.047	0.063	0.094	0.125	0.156	394
	1.0"x4.0" bearing bars run width direction	1.0"	0.013	0.026	0.039	0.051	0.077	0.102	0.128	762
	1.0"x4.0" bearing bars run width direction	1.0"	0.015	0.031	0.046	0.061	0.092	0.123	0.154	479
	1.5"x1.5"	1.25"	0.012	0.025	0.037	0.049	0.074	0.098	0.122	481
1.57"x1.57"	1.25"	0.015	0.031	0.046	0.062	0.093	0.124	0.154	477	
0.79"x0.79"/1.57"x1.57"	1.25"	0.009	0.019	0.028	0.038	0.057	0.076	0.094	782	
0.5"x0.5"/1.5"x1.5"	1.25"	0.008	0.015	0.023	0.031	0.046	0.062	0.078	948	
1.5"x1.5"	1.5"	0.006	0.011	0.017	0.022	0.033	0.044	0.056	1322	
1.57"x1.57"	1.5"	0.006	0.011	0.017	0.023	0.034	0.045	0.057	1298	
1.0"x6.0" bearing bars run length direction	1.5"		0.007	0.011	0.014	0.021	0.028	0.036	268	
1.5"x4.0" bearing bars run length direction	1.5"	0.008	0.016	0.024	0.031	0.047	0.063	0.079	933	
0.79"x0.79"/1.57"x1.57"	1.5"	0.005	0.01	0.015	0.022	0.032	0.043	0.054	1363	
2.0"x2.0"	2.0"		0.007	0.01	0.013	0.02	0.027	0.033	231	

Uniform Load con't

Molded FRP Grating Load & Deflection Data

Span	Mesh Size (in)	Ht (in)	Uniform Load (lbs/ft ²)							L/100 (lbs/ft)
			41	82	123	164	246	327	409	
1.5'	1.0"x1.0"/2.0"x2.0"	2.0"		0.006	0.009	0.013	0.019	0.026	0.032	2772
	1.5"x6.0" bearing bars run length direction	2.0"		0.006	0.009	0.013	0.018	0.025	0.03	2923
	1.5"x1.5" (0.35"/0.45")	2.0"		0.006	0.008	0.011	0.016	0.021	0.026	2579
	1.5"x1.5" (0.23"/0.35")	2.5"		0.006	0.009	0.012	0.019	0.024	0.031	249
	1.5"x1.5" (0.35"/0.48")	2.5"		0.004	0.006	0.008	0.012	0.016	0.02	3684
2'	1.0"x1.0"/2.0"x2.0"	0.59"	0.238	0.476	0.713					41
	1.5"x1.5"	0.59"	0.192	0.384	0.576					51
	0.79"x0.79"/1.57"x1.57"	0.59"	0.173	0.346	0.519					57
	0.50"x0.50"/1.5"x1.5"	0.79"	0.059	0.119	0.178	0.237	0.356	0.474	0.593	166
	1.5"x1.5"	1.0"	0.046	0.093	0.139	0.185	0.278	0.37	0.463	177
	1.57"x1.57"	1.0"	0.058	0.116	0.174	0.233	0.349	0.465	0.581	169
	0.75"x0.75"/1.5"x1.5"	1.0"	0.039	0.077	0.115	0.154	0.23	0.307	0.383	214
	1.0"x4.0" bearing bars run width direction	1.0"	0.036	0.072	0.108	0.144	0.215	0.287	0.359	326
	1.0"x4.0" bearing bars run width direction	1.0"	0.043	0.086	0.129	0.172	0.258	0.344	0.430	228
	1.5"x1.5"	1.25"	0.028	0.056	0.083	0.111	0.167	0.222	0.278	295
	1.57"x1.57"	1.25"	0.035	0.070	0.105	0.140	0.210	0.280	0.351	28
	0.79"x0.79"/1.57"x1.57"	1.25"	0.021	0.043	0.064	0.085	0.128	0.171	0.213	46
	0.5"x0.5"/1.5"x1.5"	1.25"	0.018	0.035	0.053	0.070	0.106	0.141	0.176	558
	1.5"x1.5"	1.5"	0.012	0.024	0.037	0.049	0.074	0.098	0.122	82
	1.57"x1.57"	1.5"	0.013	0.026	0.039	0.052	0.077	0.103	0.129	763
	1.0"x6.0" bearing bars run length direction	1.5"	0.008	0.016	0.024	0.032	0.048	0.065	0.081	1217
	1.5"x4.0" bearing bars run length direction	1.5"	0.018	0.036	0.054	0.072	0.107	0.143	0.179	55
	0.79"x0.79"/1.57"x1.57"	1.5"	0.011	0.022	0.033	0.044	0.067	0.089	0.111	82
	2.0"x2.0"	2.0"	0.007	0.015	0.022	0.029	0.043	0.058	0.072	1359
	1.0"x1.0"/2.0"x2.0"	2.0"	0.007	0.014	0.021	0.028	0.042	0.055	0.069	1631
	1.5"x6.0" bearing bars run length direction	2.0"	0.006	0.013	0.019	0.026	0.038	0.051	0.063	1719
	1.5"x1.5" (0.35"/0.45")	2.0"	0.006	0.011	0.017	0.022	0.033	0.044	0.056	154
	1.5"x1.5" (0.23"/0.35")	2.5"	0.006	0.012	0.018	0.024	0.035	0.047	0.059	1429
	1.5"x1.5" (0.35"/0.48")	2.5"	0.005	0.009	0.014	0.018	0.028	0.037	0.046	2149
3'	1.5"x1.5"	1.0"	0.24	0.48	0.72					51
	1.57"x1.57"	1.0"	0.158	0.317	0.474	0.633				93
	0.75"x0.75"/1.5"x1.5"	1.0"	0.215	0.429	0.643					39
	1.0"x4.0" bearing bars run width direction	1.0"	0.257	0.514	0.771					57

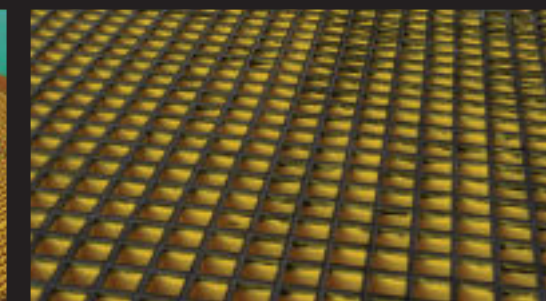
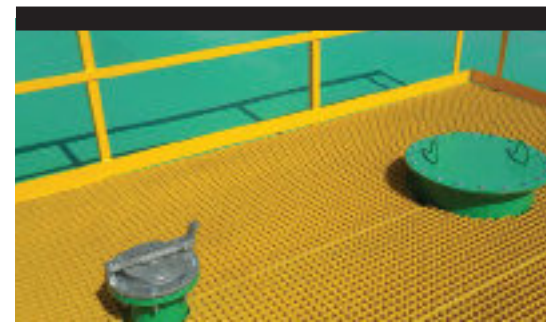

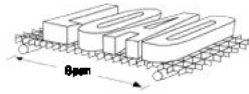

Molded FRP Grating Load & Deflection

Uniform Load con't

Span	Mesh Size (in)	Ht (in)	Uniform Load (lbs/ft ²)							L/100 (lbs/ft ²)
			41	82	123	164	246	327	409	
3'	1.0"x4.0" bearing bars run width direction	1.0"	0.225	0.450	0.675	0.900				65
	1.5"x1.5"	1.2"	0.194	0.389	0.583	0.778				76
	1.57"x1.57"	1.2"	0.206	0.411	0.617	0.822				72
	0.79"x0.79"/1.57"x1.57"	1.2"	0.092	0.185	0.277	0.369	0.554	0.738		16
	0.5"x0.5"/1.5"x1.5"	1.2"	0.083	0.165	0.248	0.331	0.496	0.662	0.827	178
	1.5"x1.5"	1.5"	0.061	0.121	0.181	0.242	0.363	0.484	0.605	244
	1.57"x1.57"	1.5"	0.066	0.132	0.198	0.264	0.396	0.528	0.660	223
	1.0"x6.0" bearing bars run length direction	1.5"	0.044	0.089	0.133	0.178	0.267	0.356	0.444	332
	1.5"x4.0" bearing bars run length direction	1.5"	0.085	0.169	0.254	0.339	0.508	0.677	0.846	174
	0.79"x0.79"/1.57"x1.57"	1.5"	0.063	0.125	0.188	0.250	0.376	0.501	0.626	235
2.0"	2.0"x2.0"	2.0"	0.035	0.070	0.106	0.141	0.211	0.282	0.353	418
	1.0"x1.0"/2.0"x2.0"	2.0"	0.030	0.059	0.088	0.117	0.176	0.235	0.294	51
	1.5"x6.0" bearing bars run length direction	2.0"	0.028	0.056	0.084	0.111	0.167	0.223	0.279	528
	1.5"x1.5" (0.35"/0.45")	2.0"	0.017	0.035	0.052	0.070	0.105	0.140	0.175	841
	1.5"x1.5" (0.23"/0.35")	2.36"	0.019	0.037	0.056	0.074	0.111	0.148	0.185	794
4'	1.5"x1.5" (0.35"/0.48")	2.36"	0.012	0.024	0.037	0.049	0.074	0.098	0.122	121
	1.5"x1.5"	1.2"	0.519							38
	1.57"x1.57"	1.2"	0.213	0.426	0.641	0.854				92
	0.79"x0.79"/1.57"x1.57"	1.2"	0.185	0.369	0.554	0.739				16
	0.5"x0.5"/1.5"x1.5"	1.2"	0.213	0.426	0.641	0.854				92
1.5"	1.02"x1.02"/2.05"x2.05"	1.2"	0.131	0.263	0.394	0.526	0.789			149
	1.5"x1.5"	1.5"	0.259	0.519	0.779					76
	1.57"x1.57"	1.5"	0.204	0.408	0.613	0.818				96
	1.0"x6.0" bearing bars run length direction	1.5"	0.114	0.228	0.343	0.457	0.686			172
	1.5"x4.0" bearing bars run length direction	1.5"	0.095	0.191	0.286	0.381	0.572	0.762		26
	0.79"x0.79"/1.57"x1.57"	1.5"	0.091	0.181	0.272	0.362	0.543	0.725		217
	2.0"x2.0"	2.0"	0.054	0.107	0.161	0.215	0.323	0.431	0.539	365
	1.0"x1.0"/2.0"x2.0"	2.0"	0.057	0.115	0.172	0.230	0.345	0.460	0.575	342
	1.5"x6.0" bearing bars run length direction	2.0"	0.038	0.075	0.113	0.151	0.226	0.301	0.377	521
	1.5"x1.5" (0.35"/0.45")	2.0"	0.051	0.105	0.156	0.210	0.315	0.420	0.525	370
1.5"	1.5"x1.5" (0.23"/0.35")	2.36"	0.057	0.111	0.168	0.222	0.333	0.444	0.555	349
	1.5"x1.5" (0.35"/0.48")	2.36"	0.036	0.072	0.111	0.147	0.222	0.294	0.366	54

AMD Pultruded FRP Grating Specifications

Item	Type	Height (in)	Standard Panel Size		Open Area	Weight (lbs/ft)
			Width (ft)	Length (ft)		
1	T4010	1.0	3, 4	8,10,12, 20	40%	2.46
2	T5010	1.0	3, 4	8,10,12, 20	50%	2.15
3	T6010	1.0	3, 4	8,10,12, 20	60%	1.74
4	I4010	1.0	3, 4	8,10,12, 20	40%	3.28
5	I5010	1.0	3, 4	8,10,12, 20	50%	2.74
6	I6010	1.0	3, 4	8,10,12, 20	60%	2.21
7	I4012	1.25	3, 4	8,10,12, 20	40%	4.12
8	I5012	1.25	3, 4	8,10,12, 20	50%	3.48
9	I6012	1.25	3, 4	8,10,12, 20	60%	2.89
10	I4015	1.5	3, 4	8,10,12, 20	40%	5.33
11	I5015	1.5	3, 4	8,10,12, 20	50%	4.57
12	I6015	1.5	3, 4	8,10,12, 20	60%	3.71
13	HD I 4015	1.5	3, 4	8,10,12, 20	40%	9
14	HD I 5015	1.5	3, 4	8,10,12, 20	50%	7.6
15	HD I 6015	1.5	3, 4	8,10,12, 20	60%	6.1
16	T 5020	2	3, 4	8,10,12, 20	50%	3.5
17	T3320	2	3, 4	8,10,12, 20	33%	4.6
18	HD I 4020	2	3, 4	8,10,12, 20	40%	11.7
19	HD I 5020	2	3, 4	8,10,12, 20	50%	9.8
20	HD I 6020	2	3, 4	8,10,12, 20	60%	7.8
21	HD I 7020	2	3, 4	8,10,12, 20	70%	6.3
22	T 5030	3	3, 4	8,10,12, 20	50%	5.3
23	T 3330	3	3, 4	8,10,12, 20	33%	6.5

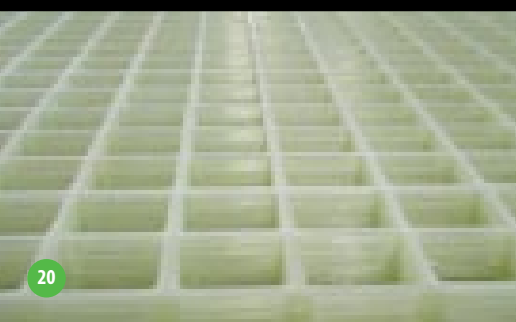

Specification drawing

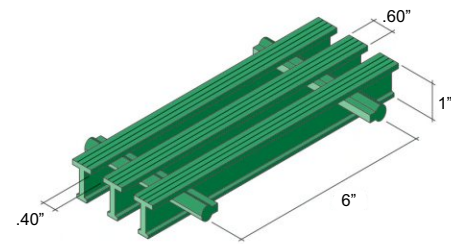

- 1 Height: 1" (T4010)
 • Standard Panel Size: width 3 ft, 4 ft
 length 7.34 ft, 10 ft, 12 ft, 20 ft,
 • Open Area: 40% • Weight: 2.4 lb/f²

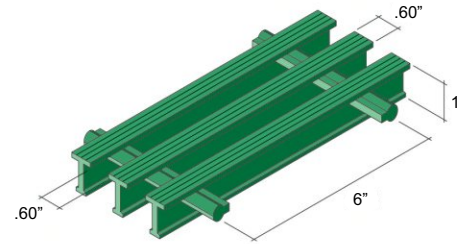

- 2 Height: 1" (T5010)
 • Standard Panel Size: width 3 ft, 4 ft
 length 8 ft, 10 ft, 12 ft, 20 ft,
 • Open Area: 50% • Weight: 2.1 lb/f²

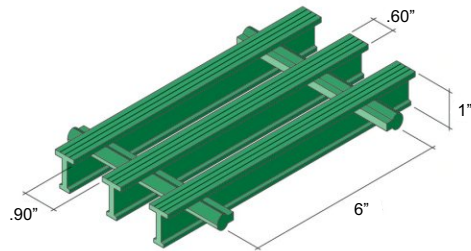

- 3 Height: 1" (T6010)
 • Standard Panel Size: width 3 ft, 4 ft
 length 8 ft, 10 ft, 12 ft, 20 ft,
 • Open Area: 60% • Weight: 1.7 lb/f²

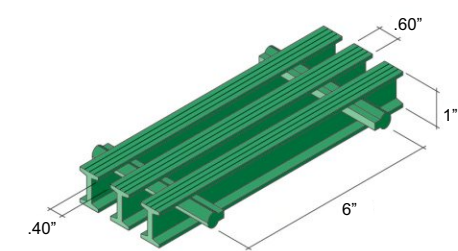

- 4 Height: 1" (I 4010)
 • Standard Panel Size: width 3 ft, 4 ft
 length 8 ft, 10 ft, 12 ft, 20 ft,
 • Open Area: 40% • Weight: 3.2 lb/f²

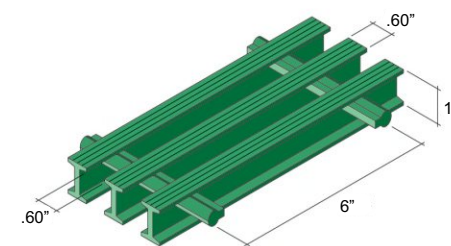

- 5 Height: 1" (I 5010)
 • Standard Panel Size: width 3 ft, 4 ft
 length 8 ft, 10 ft, 12 ft, 20 ft,
 • Open Area: 50% • Weight: 2.7 lb/f²

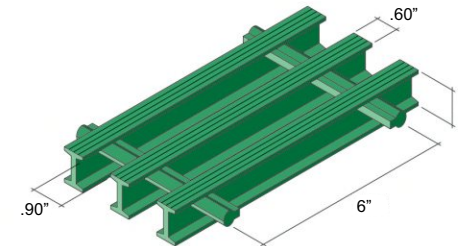

- 6 Height: 1" (I 6010)
 • Standard Panel Size: width 3 ft, 4 ft
 length 8 ft, 10 ft, 12 ft, 20 ft,
 • Open Area: 60% • Weight: 2.2 lb/f²

Specification drawing

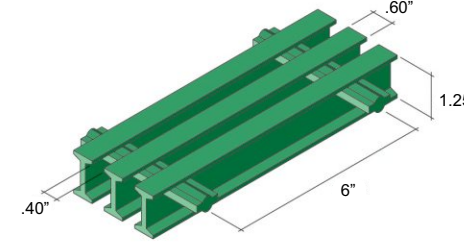

- 7 Height: 1.25" (I 4030)
 • Standard Panel Size: width 3 ft, 4 ft
 length 8 ft, 10 ft, 12 ft, 20 ft,
 • Open Area: 40% • Weight: 4.1 lb/f²

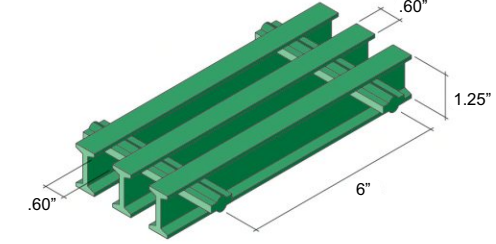

- 8 Height: 1.25" (I 5012)
 • Standard Panel Size: width 3 ft, 4 ft
 length 8 ft, 10 ft, 12 ft, 20 ft,
 • Open Area: 50% • Weight: 3.4 lb/f²

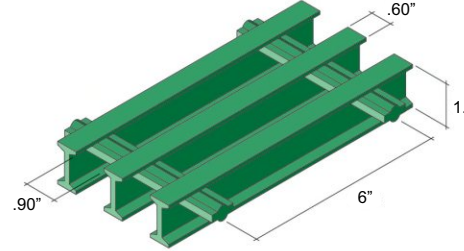

- 9 Height: 1.5" (I 6012)
 • Standard Panel Size: width 3 ft, 4 ft
 length 8 ft, 10 ft, 12 ft, 20 ft,
 • Open Area: 60% • Weight: 2.8 lb/f²

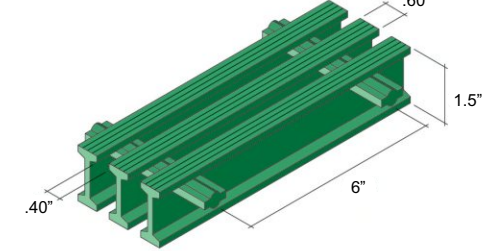

- 10 Height: 1.5" (I 4015)
 • Standard Panel Size: width 3 ft, 4 ft
 length 8 ft, 10 ft, 12 ft, 20 ft,
 • Open Area: 40% • Weight: 5.4 lb/f²

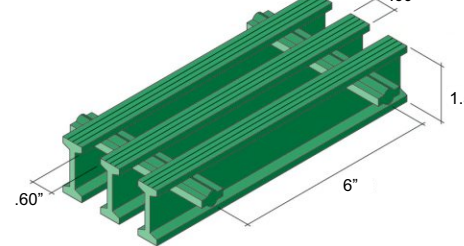

- 11 Height: 1.5" (I 5015)
 • Standard Panel Size: width 3 ft, 4 ft
 length 8 ft, 10 ft, 12 ft, 20 ft,
 • Open Area: 50% • Weight: 4.5 lb/f²

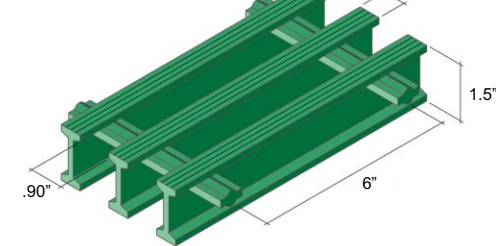

- 12 Height: 1.5" (I 6015)
 • Standard Panel Size: width 3 ft, 4 ft
 length 8 ft, 10 ft, 12 ft, 20 ft,
 • Open Area: 60% • Weight: 3.7 lb/f²

Specification drawing

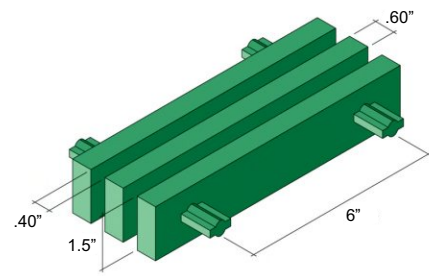

- 13 Height: 1.5" (HD I 4015)
 • Standard Panel Size: width 3 ft , 4 ft
 length 8 ft, 10 ft, 12 ft, 20 ft,
 • Open Area: 40% • Weight: 9 lb/f²

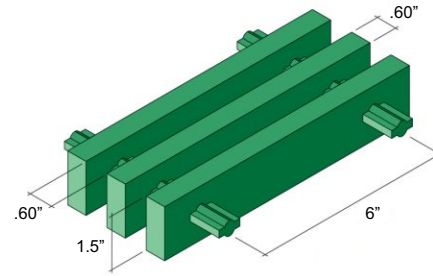

- 14 Height: 1.5" (HD I 5015)
 • Standard Panel Size: width 3 ft , 4 ft
 length 8 ft, 10 ft, 12 ft, 20 ft,
 • Open Area: 50% • Weight: 7.6 lb/f²

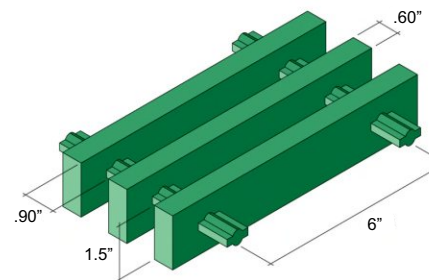

- 15 Height: 1.5" (HD I 6015)
 • Standard Panel Size: width 3 ft , 4 ft
 length 8 ft, 10 ft, 12 ft, 20 ft,
 • Open Area: 60% • Weight: 6.1 lb/f²

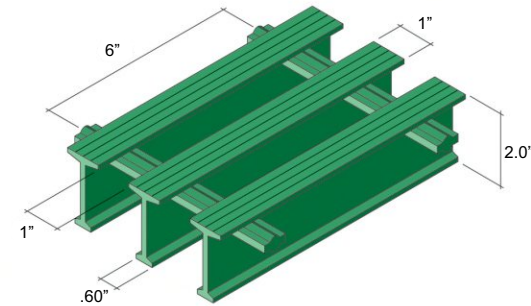

- 16 Height: 2.0" (T 5020)
 • Standard Panel Size: width 3 ft , 4 ft
 length 8 ft, 10 ft, 12 ft, 20 ft,
 • Open Area: 50% • Weight: 3.5 lb/f²

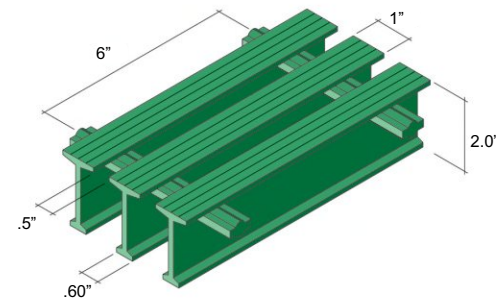

- 17 Height: 2" (T 3320)
 • Standard Panel Size: width 3 ft , 4 ft
 length 8 ft, 10 ft, 12 ft, 20 ft,
 • Open Area: 33% • Weight: 4.6 lb/f²

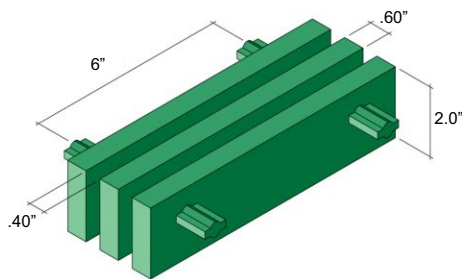

- 18 Height: 2" (HD I 4020)
 • Standard Panel Size: width 3 ft , 4 ft
 length 8 ft, 10 ft, 12 ft, 20 ft,
 • Open Area: 40% • Weight: 11.7 lb/f²

Specification drawing

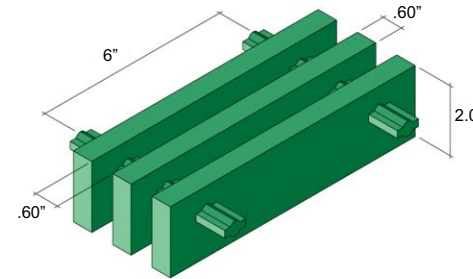

- 19 Height: 2.0" (HD I 5020)
 • Standard Panel Size: width 3 ft , 4 ft
 length 8 ft, 10 ft, 12 ft, 20 ft,
 • Open Area: 50% • Weight: 9.8 lb/f²

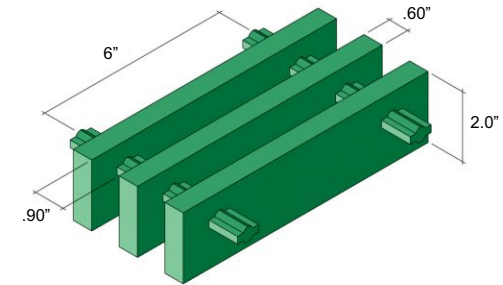

- 20 Height: 2.0" (HD I 6020)
 • Standard Panel Size: width 3 ft , 4 ft
 length 8 ft, 10 ft, 12 ft, 20 ft,
 • Open Area: 60% • Weight: 7.8 lb/f²

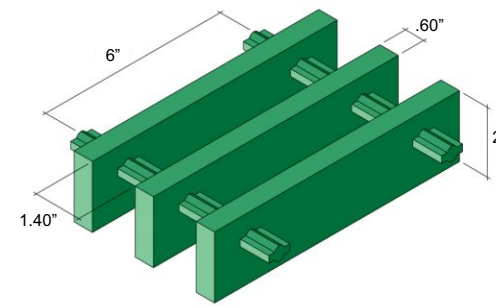

- 21 Height: 2.0" (HD I 7020)
 • Standard Panel Size: width 3 ft , 4 ft
 length 8 ft, 10 ft, 12 ft, 20 ft,
 • Open Area: 70% • Weight: 6.3 lb/f²

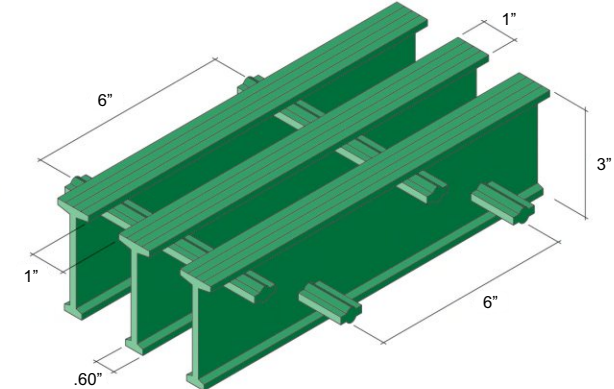

- 22 Height: 3" (T 5030)
 • Standard Panel Size: width 3 ft , 4 ft
 length 8 ft, 10 ft, 12 ft, 20 ft,
 • Open Area: 50% • Weight: 5.3 lb/f²

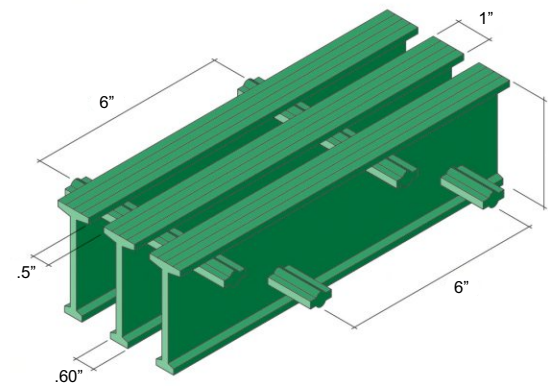

- 23 Height: 3" (T 3330)
 • Standard Panel Size: width 3 ft , 4 ft
 length 8 ft, 10 ft, 12 ft, 20 ft,
 • Open Area: 33% • Weight: 6.5 lb/f²

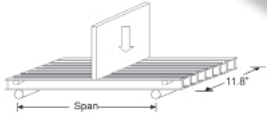

Concentrated Line Load

Pultruded FRP Grating Load & Deflection Data

Span	Specifications	Pultruded Concentrated Line Load (lbs/foot of width)									Load under 1% deflection (lbs/ft)
		110	220	440	880	1320	1760	2640	3520	4400	
1'	I-40-10	0.005	0.008	0.016	0.032	0.048	0.064	0.095	0.127	0.159	3326
	I-50-10	0.006	0.009	0.019	0.038	0.057	0.076	0.115	0.152	0.191	2772
	I-60-10	0.006	0.012	0.024	0.048	0.072	0.095	0.143	0.191	0.238	2218
	I-40-12		0.006	0.011	0.021	0.032	0.043	0.064	0.085	0.106	4990
	I-50-12		0.006	0.013	0.026	0.038	0.051	0.076	0.102	0.127	4158
	I-60-12	0.005	0.008	0.016	0.032	0.048	0.064	0.095	0.127	0.159	3326
	I-40-15			0.006	0.011	0.017	0.023	0.034	0.045	0.057	9313
	I-50-15			0.007	0.014	0.020	0.028	0.041	0.054	0.068	7762
	I-60-15		0.004	0.009	0.017	0.026	0.034	0.051	0.068	0.085	6208
1.5'	I-40-10	0.009	0.015	0.030	0.060	0.089	0.119	0.179	0.238	0.298	2218
	I-50-10	0.011	0.018	0.036	0.072	0.107	0.143	0.214	0.285	0.357	1848
	I-60-10	0.013	0.022	0.045	0.089	0.134	0.179	0.268	0.357	0.446	1478
	I-40-12	0.006	0.012	0.024	0.048	0.072	0.095	0.143	0.191	0.238	3326
	I-50-12	0.007	0.014	0.029	0.057	0.086	0.114	0.171	0.228	0.286	2772
	I-60-12	0.009	0.018	0.036	0.072	0.107	0.143	0.215	0.287	0.358	2211
	I-40-15		0.006	0.011	0.022	0.032	0.043	0.064	0.085	0.106	6208
	I-50-15		0.007	0.013	0.026	0.039	0.051	0.077	0.102	0.128	5174
	I-60-15	0.005	0.008	0.016	0.032	0.048	0.064	0.096	0.128	0.159	4140
	T-33-20		0.005	0.010	0.020	0.030	0.040	0.060	0.080	0.100	7920
	T-50-20		0.007	0.013	0.026	0.039	0.052	0.077	0.103	0.128	6160
2'	I-40-10	0.017	0.031	0.063	0.126	0.189	0.252	0.376	0.502		1531
	I-50-10	0.021	0.038	0.075	0.151	0.226	0.302	0.452			1276
	I-60-10	0.026	0.047	0.094	0.189	0.283	0.377	0.565			1021
	I-40-12	0.012	0.023	0.046	0.092	0.138	0.184	0.276	0.368	0.460	2297
	I-50-12	0.014	0.028	0.055	0.110	0.166	0.221	0.331	0.442		1914
	I-60-12	0.017	0.035	0.069	0.138	0.208	0.276	0.413	0.552		1531
	I-40-15	0.006	0.012	0.024	0.047	0.071	0.094	0.141	0.188	0.235	4286
	I-50-15	0.008	0.015	0.028	0.056	0.085	0.113	0.169	0.226	0.282	3573
	I-60-15	0.009	0.018	0.035	0.071	0.106	0.141	0.211	0.282	0.352	2858
	T-33-20		0.007	0.015	0.029	0.043	0.067	0.087	0.116	0.145	7304
	T-50-20	0.005	0.010	0.020	0.039	0.059	0.079	0.118	0.157	0.197	5368
	T-33-30			0.005	0.010	0.015	0.019	0.029	0.039	0.048	21912
	T-50-30			0.007	0.013	0.020	0.026	0.039	0.052	0.066	16104
3'	I-40-10	0.050	0.100	0.200	0.400	0.600	0.800				792
	I-50-10	0.060	0.120	0.240	0.480	0.720					660
	I-60-10	0.075	0.150	0.300	0.600	0.900					528
	I-40-12	0.033	0.067	0.133	0.267	0.400	0.533	0.800			1188

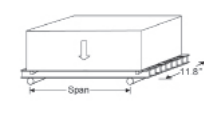
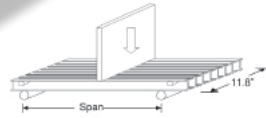

Pultruded FRP Grating Load & Deflection Data

Concentrated Line Load con't

Uniform Load

Pultruded FRP Grating Load & Deflection Data

Span	Specifications	Pultruded Concentrated Line Load (lbs/foot of width)									Load under 1% deflection (lbs/ft)
		110	220	440	880	1320	1760	2640	3520	4400	
3'	I-50-15	0.021	0.043	0.086	0.171	0.257	0.343	0.514	0.685	0.857	1848
	I-60-15	0.027	0.054	0.107	0.214	0.321	0.428	0.643	0.857		1478
	T-33-20	0.011	0.023	0.046	0.091	0.137	0.183	0.274	0.365	0.457	3467
	T-50-20	0.015	0.030	0.061	0.122	0.183	0.244	0.365	0.487	0.609	2600
	T-33-30		0.007	0.015	0.030	0.046	0.061	0.091	0.122	0.152	10402
	T-50-30	0.005	0.010	0.020	0.041	0.061	0.081	0.122	0.162	0.203	7801
	4'	I-40-10	0.106	0.211	0.421	0.843					
I-50-10		0.126	0.253	0.504	1.011						418
I-60-10		0.160	0.320	0.641	1.281						330
I-40-12		0.070	0.141	0.283	0.565	0.848					748
I-50-12		0.084	0.169	0.337	0.674	1.011					627
I-60-12		0.106	0.211	0.421	0.843						502
I-40-15		0.038	0.075	0.150	0.301	0.452	0.602	0.904			1404
I-50-15		0.045	0.091	0.181	0.362	0.544	0.725	1.087			1166
I-60-15		0.057	0.113	0.226	0.452	0.678	0.904				935
T-33-20		0.023	0.045	0.091	0.181	0.272	0.362	0.544	0.725	0.906	2332
T-50-20		0.030	0.060	0.121	0.242	0.363	0.483	0.725	0.967		1749
T-33-30		0.007	0.015	0.030	0.060	0.091	0.121	0.181	0.242	0.302	6996
T-50-30		0.010	0.020	0.040	0.081	0.121	0.161	0.242	0.322	0.403	5247
4.5'		I-40-10	0.147	0.294	0.587	1.174					
	I-50-10	0.175	0.351	0.702	1.403						339
	I-60-10	0.218	0.435	0.871	1.743						273
	I-40-12	0.098	0.196	0.391	0.783						607
	I-50-12	0.117	0.235	0.470	0.939						506
	I-60-12	0.145	0.291	0.581	1.162						409
	I-40-15	0.052	0.105	0.210	0.420	0.629	0.839				1133
	I-50-15	0.063	0.126	0.251	0.502	0.754	1.005				946
	I-60-15	0.078	0.156	0.311	0.623	0.934					763
	T-33-20	0.032	0.064	0.129	0.257	0.386	0.515	0.772			1848
	T-50-20	0.043	0.086	0.172	0.343	0.515	0.686	1.029			1386
	T-33-30	0.011	0.021	0.043	0.086	0.129	0.172	0.257	0.343	0.429	5544
	T-50-30	0.014	0.029	0.057	0.114	0.172	0.229	0.318	0.457	0.572	4158
	5'	I-40-15	0.075	0.150	0.300	0.600	0.900				
I-50-15		0.090	0.180	0.359	0.719	1.078					735
I-60-15		0.112	0.224	0.448	0.896						590
T-33-20		0.047	0.094	0.187	0.375	0.563	0.750	1.125			1408
T-50-20		0.063	0.125	0.250	0.500	0.750	1.000				1056
T-33-30		0.016	0.031	0.063	0.125	0.187	0.250	0.375	0.500	0.625	4224
T-50-30		0.021	0.042	0.083	0.167	0.256	0.333	0.500	0.667	0.833	3168
5.5'	T-33-20	0.065	0.131	0.261	0.522	0.782	1.043				1113
	T-50-20	0.087	0.174	0.347	0.694	1.042					1848
	T-33-30	0.022	0.043	0.087	0.174	0.261	0.348	0.522	0.696	0.869	1478
	T-50-30	0.029	0.058	0.116	0.231	0.347	0.463	0.694	0.926		3467

Span	Specifications	Uniform Load (lbs/foot ²)									Load under 0.5% deflection (lbs/ft ²)
		41	82	123	164	246	327	409	512	614	
1'	I-40-10				0.004	0.006	0.008	0.010	0.012	0.015	2512
	I-50-10				0.005	0.007	0.009	0.012	0.015	0.018	2093
	I-60-10			0.005	0.006	0.009	0.012	0.015	0.019	0.022	1675
	I-40-12					0.004	0.005	0.007	0.008	0.010	3767
	I-50-12					0.005	0.006	0.008	0.010	0.012	3140
	I-60-12				0.004	0.006	0.008	0.010	0.012	0.015	2512
	I-40-15								0.005	0.006	7032
	I-50-15							0.004	0.006	0.006	5861
1.5'	I-40-10		0.005	0.007	0.009	0.013	0.018	0.022	0.028	0.033	1665
	I-50-10		0.006	0.008	0.011	0.016	0.021	0.027	0.033	0.040	1387
	I-60-10		0.007	0.010	0.013	0.020	0.027	0.033	0.041	0.050	1110
	I-40-12			0.005	0.006	0.009	0.012	0.015	0.019	0.022	2497
	I-50-12				0.006	0.007	0.011	0.014	0.018	0.022	2081
	I-60-12		0.005	0.007	0.009	0.013	0.018	0.022	0.028	0.033	1665
	I-40-15					0.005	0.006	0.008	0.010	0.012	4661
	I-50-15					0.006	0.008	0.009	0.012	0.014	3884
2'	I-40-10	0.007	0.014	0.021	0.028	0.042	0.056	0.070	0.087	0.105	705
	I-50-10	0.009	0.017	0.025	0.033	0.050	0.067	0.083	0.105	0.126	587
	I-60-10	0.011	0.021	0.031	0.042	0.063	0.084	0.105	0.131	0.157	470
	I-40-12	0.005	0.009	0.014	0.019	0.028	0.037	0.046	0.058	0.070	1058
	I-50-12	0.006	0.011	0.017	0.022	0.033	0.044	0.056	0.070	0.084	881
	I-60-12	0.007	0.014	0.021	0.028	0.042	0.056	0.070	0.087	0.105	705
	I-40-15		0.005	0.007	0.010	0.015	0.020	0.025	0.031	0.037	1974
	I-50-15		0.006	0.009	0.012	0.018	0.024	0.030	0.037	0.045	1645
3'	I-40-10	0.031	0.064	0.095	0.127	0.191	0.254	0.318	0.397	0.477	232
	I-50-10	0.039	0.076	0.115	0.153	0.229	0.306	0.382	0.477	0.572	193
	I-60-10	0.048	0.095	0.143	0.191	0.286	0.381	0.477	0.596	0.715	155
	I-40-12	0.021	0.043	0.064	0.085	0.127	0.170	0.212	0.265	0.318	348
	I-50-12	0.026	0.051	0.076	0.102	0.153	0.204	0.254	0.318	0.382	289
	I-60-12	0.032	0.063	0.095	0.127	0.191	0.254	0.318	0.397	0.477	232
	I-40-15	0.011	0.023	0.034	0.045	0.068	0.091	0.113	0.142	0.170	649
	I-50-15	0.014	0.028	0.041	0.054	0.082	0.109	0.136	0.170	0.205	540
T-33-20	I-60-15	0.017	0.034	0.051	0.068	0.102	0.136	0.170	0.213	0.256	433
	T-33-20	0.007	0.014	0.021	0.028	0.043	0.057	0.071	0.089	0.106	1038

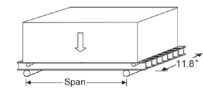

Pultruded FRP Grating Load & Deflection Data

Uniform Load con't

Span	Specifications	Uniform Load (lbs/ft ²)									Load under 0.5% deflection (lbs/ft ²)
		41	82	123	164	246	327	409	512	614	
3'	T-50-20	0.009	0.019	0.028	0.038	0.057	0.076	0.094	0.118	0.142	779
	T-33-30		0.005	0.007	0.009	0.014	0.019	0.024	0.030	0.035	3115
	T-50-30		0.006	0.009	0.013	0.019	0.025	0.031	0.039	0.047	2336
4'	I-40-10	0.100	0.200	0.300	0.400	0.600	0.800				98
	I-50-10	0.120	0.240	0.360	0.480	0.720	0.961				82
	I-60-10	0.150	0.300	0.450	0.600	0.901					65
	I-40-12	0.067	0.133	0.200	0.267	0.400	0.534	0.667	0.834		147
	I-50-12	0.080	0.160	0.240	0.320	0.480	0.641	0.801			123
	I-60-12	0.008	0.200	0.300	0.400	0.600	0.800				98
	I-40-15	0.036	0.072	0.107	0.143	0.214	0.286	0.357	0.447	0.536	275
	I-50-15	0.043	0.086	0.129	0.172	0.257	0.343	0.429	0.536	0.643	229
	I-60-15	0.054	0.107	0.161	0.215	0.322	0.429	0.536	0.670	0.804	183
	T-33-20	0.022	0.043	0.065	0.086	0.129	0.172	0.215	0.269	0.322	458
	T-50-20	0.029	0.057	0.086	0.115	0.172	0.229	0.286	0.358	0.430	343
	T-33-30	0.007	0.014	0.022	0.029	0.043	0.057	0.072	0.089	0.107	1373
	T-50-30	0.009	0.019	0.029	0.038	0.057	0.076	0.096	0.119	0.143	1029
4.5'	I-40-12	0.123	0.247	0.370	0.493	0.740	0.987				90
	I-50-12	0.148	0.296	0.444	0.592	0.888					75
	I-60-12	0.185	0.370	0.555	0.740	1.110					60
	I-40-15	0.066	0.132	0.198	0.264	0.396	0.528	0.659	0.824		168
	I-50-15	0.079	0.158	0.238	0.317	0.475	0.633	0.792			140
	I-60-15	0.099	0.198	0.297	0.396	0.594	0.791				112
	T-33-20	0.041	0.083	0.124	0.165	0.247	0.330	0.412	0.515	0.619	268
	T-50-20	0.055	0.110	0.165	0.220	0.330	0.440	0.550	0.688	0.825	201
	T-33-30	0.014	0.028	0.041	0.055	0.083	0.110	0.138	0.172	0.206	804
T-50-30	0.019	0.037	0.055	0.073	0.110	0.147	0.183	0.229	0.275	603	
5'	I-40-15	0.088	0.176	0.263	0.351	0.526	0.702	0.877			140
	I-50-15	0.105	0.211	0.316	0.421	0.631	0.843				117
	I-60-15	0.131	0.263	0.395	0.526	0.789					93
	T-33-20	0.055	0.110	0.165	0.219	0.329	0.439	0.548	0.685	0.823	224
	T-50-20	0.073	0.146	0.220	0.293	0.439	0.585	0.732	0.915		168
	T-33-30	0.019	0.037	0.055	0.073	0.110	0.146	0.183	0.228	0.274	672
	T-50-30	0.024	0.049	0.073	0.098	0.146	0.195	0.244	0.305	0.366	503
5.5'	T-33-20	0.084	0.168	0.252	0.335	0.503	0.671	0.839			161
	T-50-20	0.112	0.224	0.335	0.447	0.671	0.895				121
	T-33-30	0.028	0.056	0.084	0.112	0.168	0.224	0.280	0.350	0.419	483
	T-50-30	0.037	0.075	0.112	0.149	0.224	0.298	0.373	0.466	0.559	362

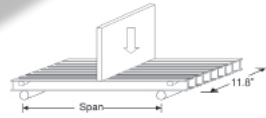

Concentrated Line Load

HD Pultruded Grating Load & Deflection Data

Span	Specifications	Pultruded Concentrated Line Load (lbs/foot of width)								
		110	220	440	880	1320	1760	2640	3520	4400
3'	II-40-15	0.024	0.048	0.095	0.143	0.190	0.285	0.380	0.474	
	II-50-15	0.026	0.052	0.104	0.157	0.209	0.313	0.417	0.522	
	II-60-15	0.033	0.065	0.131	0.196	0.261	0.391	0.522	0.652	
4'	II-40-15	0.052	0.104	0.207	0.311	0.414	0.621			
	II-50-15	0.062	0.124	0.248	0.373	0.497	0.746			
	II-60-15	0.078	0.156	0.311	0.466	0.621	0.932			
	II-40-20	0.023	0.046	0.091	0.137	0.182	0.273	0.364	0.455	
	II-50-20	0.027	0.055	0.109	0.164	0.219	0.328	0.437	0.546	
	II-60-20	0.034	0.069	0.137	0.205	0.273	0.409	0.546	0.682	
4.5'	II-40-15	0.074	0.147	0.294	0.442	0.589				
	II-50-15	0.089	0.177	0.353	0.530	0.706				
	II-60-15	0.111	0.221	0.441	0.662	0.883				
	II-40-20	0.032	0.065	0.130	0.194	0.259	0.388	0.517	0.646	
	II-50-20	0.039	0.078	0.156	0.233	0.311	0.466	0.621	0.776	
	II-60-20	0.049	0.097	0.194	0.291	0.388	0.583	0.776	0.970	
5'	II-40-20	0.045	0.089	0.178	0.266	0.354	0.532	0.709		
	II-50-20	0.054	0.107	0.213	0.320	0.426	0.639	0.851		
	II-60-20	0.067	0.133	0.266	0.400	0.532	0.798	1.063		
5.5'	II-40-20	0.059	0.119	0.236	0.355	0.472	0.707			
	II-50-20	0.071	0.142	0.283	0.425	0.566	0.849			
	II-60-20	0.089	0.177	0.354	0.531	0.708	1.061			

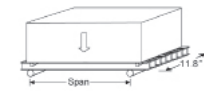

Uniform Load

HD Pultruded FRP Grating Load & Deflection Data

Span	Specifications	Uniform Load (lbs/foot ²)						
		82	164	246	327	409	512	614
3'	II-40-15	0.015	0.030	0.045	0.060	0.075	0.094	0.112
	II-50-15	0.019	0.036	0.054	0.072	0.091	0.114	0.135
	II-60-15	0.024	0.046	0.069	0.092	0.115	0.144	0.172
4'	II-40-15	0.048	0.095	0.143	0.190	0.237	0.297	0.355
	II-50-15	0.058	0.115	0.172	0.230	0.287	0.359	0.430
	II-60-15	0.073	0.146	0.219	0.291	0.364	0.455	0.546
	II-40-20	0.021	0.042	0.063	0.083	0.104	0.131	0.156
	II-50-20	0.025	0.050	0.076	0.101	0.126	0.158	0.189
	II-60-20	0.032	0.065	0.096	0.128	0.161	0.201	0.240
4.5'	II-40-15	0.084	0.168	0.251	0.335	0.419	0.524	0.628
	II-50-15	0.089	0.178	0.267	0.356	0.445	0.555	0.665
	II-60-15	0.113	0.226	0.339	0.450	0.563	0.704	0.844
	II-40-20	0.034	0.067	0.100	0.134	0.167	0.209	0.250
	II-50-20	0.041	0.081	0.122	0.161	0.202	0.252	0.302
	II-60-20	0.041	0.081	0.122	0.161	0.202	0.252	0.302
5'	II-40-20	0.051	0.102	0.152	0.203	0.254	0.317	0.380
	II-50-20	0.062	0.123	0.184	0.246	0.307	0.384	0.460
	II-60-20	0.062	0.123	0.184	0.246	0.307	0.384	0.460
5.5'	II-40-20	0.075	0.150	0.222	0.296	0.371	0.463	0.556
	II-50-20	0.091	0.180	0.270	0.359	0.449	0.563	0.674
	II-60-20	0.114	0.228	0.343	0.457	0.571	0.713	0.855

Features of Fiberglass Ladders & Platforms

LADDERS

AMD custom builds above ground fiberglass ladders to suit your individual requirements per OSHA specifications. AMD ladders are ideal for use with catwalks, mezzanines, roof access, and tanks. Safety cages, safety rail/trolley, removable extensions and walk thrus are optional. Ladders are fabricated using pultruded fiberglass reinforced plastic shapes (FRP materials). Standard wall and floor mounting brackets are INCLUDED.

We build both heavy duty and standard duty ladders. Let us provide you a solution to meet your specific application.

FEATURES

- Corrosion Resistant
- Safety Yellow
- Maintenance Free
- Non-Skid Rungs
- Light Weight - Reduced Freight & Install Costs
- Non-Conductive - Heat & Electric
- Per OSHA and ANSI Standards

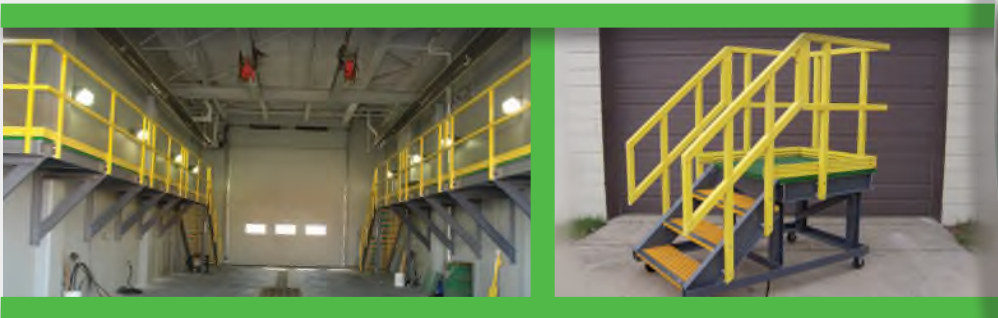

PLATFORMS

Each AMD platform is custom manufactured utilizing our CAD design build process to accurately meet the application requirements. Fiberglass platforms are completely factory assembled and tested to ensure quality. Platforms are then broken down for shipping and marked for easy assembly in the field. This reduces installation costs and improves efficiency.

The lightweight characteristic of structural fiberglass facilitates simple on-site assembly and reduces shipping costs. AMD platforms meet or exceed all OSHA standards and can be designed to comply with International Building Code (IBC) standards.

FEATURES

- Corrosion Resistant
- Safety Yellow
- Maintenance Free
- Non-Skid Rungs
- Light Weight - Reduced Freight & Install Costs
- Non-Conductive - Heat & Electric
- Per OSHA and ANSI Standards





Features of Fiberglass Handrails & Structural Fiberglass Fabrications

HANDRAIL SYSTEMS

AMD Fiberglass will custom design and fabricate Fiberglass Handrail Systems to meet your specifications. Our Fiberglass Handrail components are safety yellow including the FRP M-shaped toe plate. Fiberglass Handrail Systems are shipped in assembled sections up to 20' long. A Fiberglass Handrail can be built for attachment with new or existing stairways and walkways.

FEATURES

- Non-Conductive - Heat & Electric
- Maintenance Free
- Light Weight
- High Strength
- Corrosion Resistant
- Safety Yellow
- Fire Retardant
- Exceeds OSHA Standards

STRUCTURAL FIBERGLASS FABRICATION

AMD provides turnkey structural fiberglass design and fabrication of fiberglass structures and structural systems, as well as the distribution of fiberglass materials. We will provide initial concept through design; including in-house CAD, custom fiberglass fabrication and installation.

FEATURES

- Superior Strength/Weight
- Corrosion Resistant
- Low Maintenance
- Fire Retardant
- Non-Conductive - Heat & Electric

INDUSTRIES

- Brewing
- Chemical Processing
- Dairy
- Electrical
- Food Processing
- Hydro
- Marine
- Pulp & Paper
- Power Plant
- Transportation
- Water Treatment
- Waste Water



Pultruded FRP Profiles

Pultruded FRP profiles are with the constant cross-section structure by a continuous pultrusion process using fiberglass reinforcements with thermosetting resin matrixes. Pre-selected reinforcement materials, such as fiberglass roving, mat, woven fabrics or stitched fabric, are drawn through a resin bath in which all materials are thoroughly impregnated with a liquid thermosetting resin. Typical resins included polyester, vinyl esters and phenolic resin.

Any constant cross-section profiles can be pultruded. Pultrusion allows the designer to customize the selection of the resin system, the type and form of fiberglass reinforcements, and the placement of the reinforcements within the composite profile. Typical pultruded profiles include FRP Angle, Square Tube, I Beam, Channel, Round Rod, Round Tube, T Beam, etc. They are widely used as handrail, support, beam and other structure materials in the industries of chemical, power, infrastructure, etc.



Specifications of Main Pultruded FRP Profiles

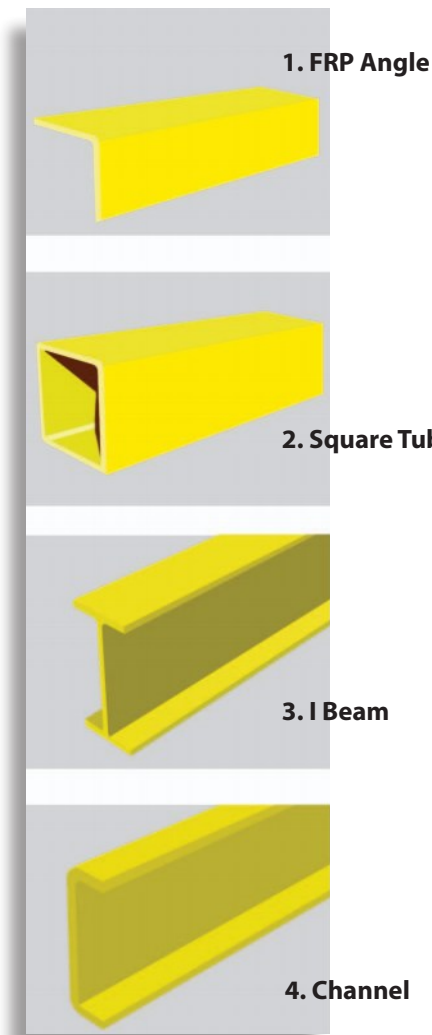

Cross-section measurement (in)	Unit weight (lb/ft)
1.181x1.181x0.201	0.333
1.378x1.18x0.201	0.406
1.575x1.575x0.157	0.366
1.771x1.771x0.201	0.515
2x2x0.25	0.773
3x3x0.375	1.760
4x4x0.375	2.167
6x6x0.511	4.591

Cross-section measurement (in)	Unit weight (lb/ft)
1.575x0.157	0.650
2x0.126	0.726
2x0.189	1.112
2x0.25	1.463
2.362x0.157	1.119
3x0.25	2.302
4x0.25	3.047

Cross-section measurement (in)	Unit weight (lb/ft)
3.937x1.969x0.25	1.625
3.937x3.937x0.2	2.573
6x4.921x0.375	5.079
6x6x0.25	3.590
6x6x0.375	5.297
7.48x4.921x0.393	5.961
7.874x3.937x0.375	5.215
9.842x4.921x0.472	7.448

Cross-section measurement (in)	Unit weight (lb/ft)
0.866x0.708x0.157	0.293
1.0x0.438x0.125	0.158
2.913x1.0x0.198	0.746
3.0x1.5x0.25	1.132
6.299x1.771x0.315	2.169
8.0x2.165x0.375	3.590

Diameter (in)	Unit weight (lb/ft)
0.315	0.067
0.393	0.109
0.472	0.151

Cross-section measurement (in) (Diameter X thickness in)	Unit weight (lb/ft)
0.708x0.118	0.171
1.181x0.118	0.326
1.574x0.157	0.571
1.968x0.25	1.132
1.698x0.157	0.759
2.362x0.196	1.119
2.559x0.25	1.476
2.952x0.137	0.133

Cross-section measurement (in)	Unit weight (lb/ft)
1.574x2.440x0.393	1.017
1.771x2.125x0.236	0.679

Cross-section measurement (in)	Unit weight (lb/ft)
1.0x1.5x0.25	.0746
1.5x1.5x0.25	0.881
2.0x1.5x0.25	0.950

Cross-section measurement (in)	Unit weight (lb/ft)
4.0x0.134	0.522
5.826x0.118	0.670

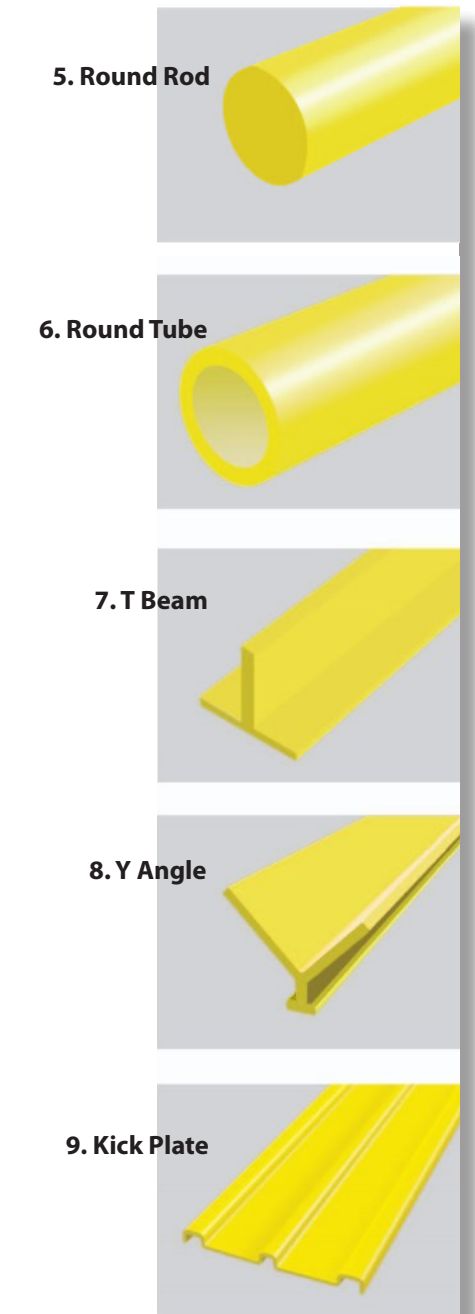

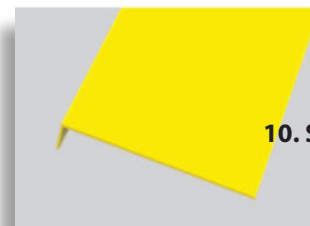

10. Step Cover

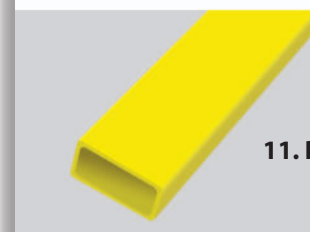

11. Regular Tube

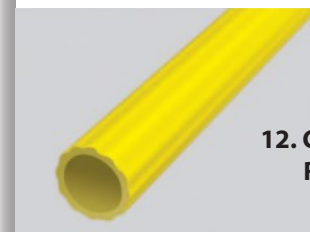

12. Corrugated Round Tube

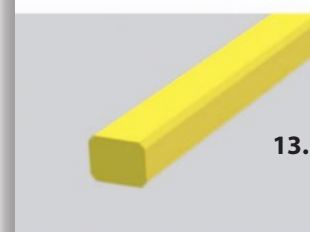

13. Rectangular Bar



14. U-Profile for Handrail

Cross-section measurement (in)	Unit weight (lb/ft)
2.165x13.779x0.118	.1525
2.165x13.779x0.157	1.965
2.165x2.755x0.118	0.455
2.165x2.165x0.157	0.515

Cross-section measurement (in)	Unit weight (lb/ft)
2.362x1.181x0.104x0.118	0.604
2.047x1.259x0.197x0.197	0.950
6.89x2.16x0.197	2.844

Cross-section measurement (in)	Unit weight (lb/ft)
1.259x1.181x0.108	0.360
1.259x1.141x0.098	0.353
1.330x1.220x0.108	0.435

Cross-section measurement (in)	Unit weight (lb/ft)
2.165x1.575	2.844
2x2.125	3.216
1.377x0.787	0.942

Cross-section measurement (in)	Unit weight (lb/ft)
2.795x2.362x0.177	.928

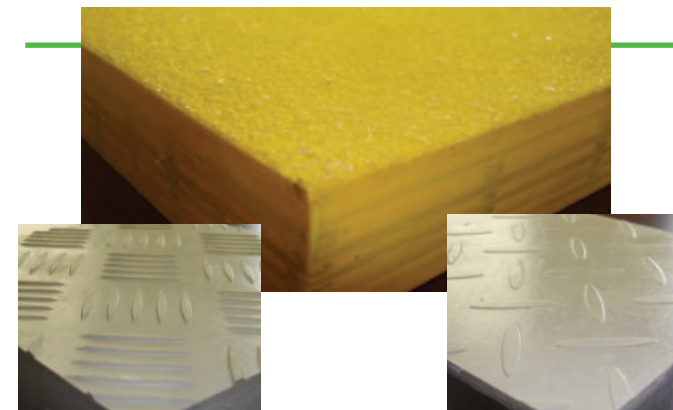

Covered Solid Top Gratings

When an impervious solid top surface is necessary, AMD, inc. offers a wide variety of Molded FRP Covered Gratings. This is achieved by taking our FRP Molded Grating panels and sealing a custom plated sheet to the top of the grating.

Plated Sheet panels are available in a number of different thicknesses and Surface Finishes. Our current available surface finishes include a Smooth Top, Diamond Plate, or with our Anti-Skid Grit Top surface.

Our staff will work closely with you to determine the best thickness of plated grating for each individual project. Please inquire at www.amdgrating.com

Custom Pedestals

AMD Fiberglass Custom Pedestals serve as an excellent way to both elevate and provide structural support to your FRP Fiberglass Grating. These pedestals come in a variety of heights and with the option to have a fixed height or an adjustable height feature. Please contact us for an in depth consultation regarding your choices.



Stainless Steel Clips M & C

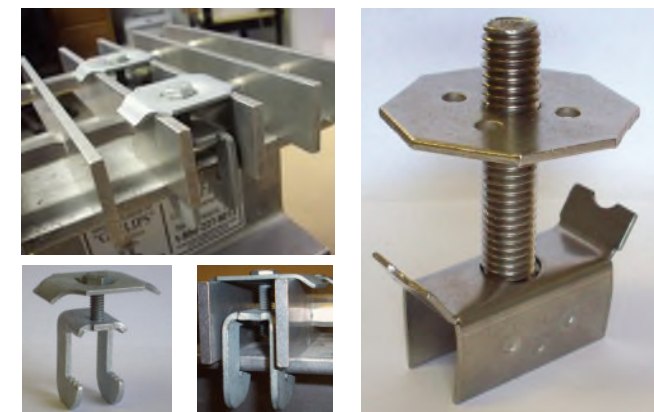

In order to fasten and secure your FRP grating to a structural frame, AMD, inc. recommends the use of our 316 Stainless Steel "M" Clips. The "M" clips will provide the proper strength and corrosion resistance for almost any application without creating a trip hazard.

When you need to "tie" or fasten two adjoining panels together, we recommend the use of our 316 Stainless Steel "C" Clips. The use of "C" clips will secure the two panels together and give it the structural rigidity to support light to medium traffic.

Please contact AMD, inc. to help determine the best use of our clips for your project.

FRP Stair Treads

FRP Fiberglass Stair Treads provide the non slip and ergonomic support that you need to keep your workplace safe. All of our Treads are custom designed to your specifications and are available in a wide variety of thicknesses, colors, and mesh sizes. Contact our support staff to help design your existing or new stair case system.



Assorted Gratings & Moulds

At AMD, inc. we try to provide the best possible grating and platform systems while continuing to stay within your specific budget.

In addition to the products offered in our catalogue we have the ability to make custom moulds, specialty fiberglass, and custom designed gratings. If you have a particular product in mind or are interested in something that you don't see listed in our catalogue, please contact us at 847-593-1800 or at sales@amdgrating.com and one of our dedicated staff members will find a solution to make your project a success.

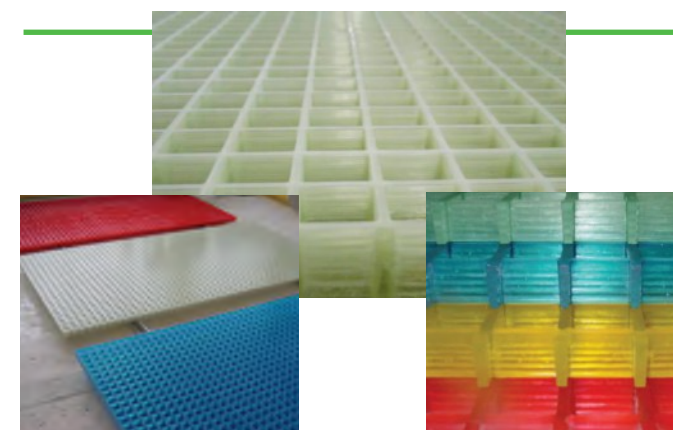



1970 South Carboy Road, Mount Prospect, IL 60056

847-593-1800 Fax 847-593-1830

www.amdgrating.com